



The new degree of comfort.™

Rheem Classic® Series Air Conditioners



RA13 Series

Efficiencies 13-15.5 SEER/11.5-13 EER
Nominal Sizes 1½ to 5 Ton [5.28 to 17.6 kW]
Cooling Capacities 17.3 to 60.5 kBTU
[5.7 to 17.7 kW]



“Proper sizing and installation of equipment is critical to achieve optimal performance. Split system air conditioners and heat pumps must be matched with appropriate coil components to meet Energy Star. Ask your Contractor for details or visit www.energystar.gov.”

- New composite base pan – dampens sound, captures louver panels, eliminates corrosion and reduces number of fasteners needed
- Powder coat paint system – for a long lasting professional finish
- Scroll compressor – uses 70% fewer moving parts for higher efficiency and increased reliability
- Modern cabinet aesthetics – increased curb appeal with visually appealing design
- Curved louver panels – provide ultimate coil protection, enhance cabinet strength, and increased cabinet rigidity
- Optimized fan orifice – optimizes airflow and reduces unit sound
- Rust resistant screws – confirmed through 1500-hour salt spray testing
- PlusOne™ **Expanded Valve Space** – 3"-4"-5" service valve space – provides a minimum working area of 27-square inches for easier access
- PlusOne™ **Triple Service Access** – 15" wide, industry leading corner service access – makes repairs easier and faster. The two fastener removable corner allows optimal access to internal unit components. Individual louver panels come out once fastener is removed, for faster coil cleaning and easier cabinet reassembly
- Diagnostic service window with two-fastener opening – provides access to the high and low pressure.
- External gauge port access – allows easy connection of “low-loss” gauge ports
- Single-row condenser coil – makes unit lighter and allows thorough coil cleaning to maintain “out of the box” performance
- 35% fewer cabinet fasteners and fastener-free base – allow for faster access to internal components and hassle-free panel removal
- Service trays – hold fasteners or caps during service calls
- QR code – provides technical information on demand for faster service calls
- Fan motor harness with extra long wires allows unit top to be removed without disconnecting fan wire.



TABLE OF CONTENTS

| | |
|---|-------|
| Standard Feature | 3 |
| Available SKUs | 3 |
| Features & Benefits | 4-5 |
| Model Number Identification | 6-7 |
| General Data/Electrical Data | 8 |
| Accessories | 9 |
| Weighted Sound Power | 9 |
| Thermostats..... | 9 |
| Unit Dimensions..... | 10 |
| Clearances..... | 11 |
| Wiring Diagrams | 12 |
| Application Guidelines | 12 |
| Refrigerant Line Size Information | 13-14 |
| Performance Data | 15-45 |
| Guide Specifications | 46 |
| Limited Warranty | 47 |



Air

Standard Feature/Available SKUs
RA13 Series

Standard Feature Table

| Feature | STANDARD FEATURES | | | | | | |
|-------------------------------------|-------------------|------|------|------|------|------|------|
| | 18 | 24 | 30 | 36 | 42 | 48 | 60 |
| R-410a Refrigerant | √ | √ | √ | √ | √ | √ | √ |
| Maximum SEER | 15.1 | 15.0 | 15.5 | 15.1 | 14.5 | 14.5 | 14.0 |
| Maximum EER | 12.5 | 12.5 | 13.0 | 12.5 | 12.0 | 12.0 | 11.5 |
| Scroll Compressor | √ | √ | √ | √ | √ | √ | √ |
| Field Installed Filter Drier | √ | √ | √ | √ | √ | √ | √ |
| Front Seating Service Valves | √ | √ | √ | √ | √ | √ | √ |
| Internal Pressure Relief Valve | √ | √ | √ | √ | √ | √ | √ |
| Internal Thermal Overload | √ | √ | √ | √ | √ | √ | √ |
| Long Line capability | √ | √ | √ | √ | √ | √ | √ |
| Low Ambient capability with Kit | √ | √ | √ | √ | √ | √ | √ |
| 3-4-5 Expanded Valve Space | √ | √ | √ | √ | √ | √ | √ |
| Composite Basepan | √ | √ | √ | √ | √ | √ | √ |
| 2 Screw Control Box Access | √ | √ | √ | √ | √ | √ | √ |
| 15" Access to Internal Components | √ | √ | √ | √ | √ | √ | √ |
| Quick release louver panel design | √ | √ | √ | √ | √ | √ | √ |
| No fasteners to remove along bottom | √ | √ | √ | √ | √ | √ | √ |
| Optimized Venturi Airflow | √ | √ | √ | √ | √ | √ | √ |
| Single row condenser coil | √ | √ | √ | √ | √ | √ | √ |
| Powder coated paint | √ | √ | √ | √ | √ | √ | √ |
| Rust resistant screws | √ | √ | √ | √ | √ | √ | √ |
| QR code | √ | √ | √ | √ | √ | √ | √ |
| External gauge ports | √ | √ | √ | √ | √ | √ | √ |
| Service trays | √ | √ | √ | √ | √ | √ | √ |

√ = Standard

Available SKUs

| Available Models | Description |
|------------------|--|
| RA1318AJ1NA | Classic® Series 1 1/2 ton 13 SEER Single-Stage Air Conditioner-208/230/1/60 |
| RA1324AJ1NA | Classic® Series 2 ton 13 SEER Single-Stage Air Conditioner-208/230/1/60 |
| RA1330AJ1NA | Classic® Series 2 1/2 ton 13 SEER Single-Stage Air Conditioner-208/230/1/60 |
| RA1336AJ1NA | Classic® Series 3 ton 13 SEER Single-Stage Air Conditioner-208/230/1/60 |
| RA1342AJ1NA | Classic® Series 3 1/2 ton 13 SEER Single-Stage Air Conditioner-208/230/1/60 |
| RA1348AJ1NA | Classic® Series 4 ton 13 SEER Single-Stage Air Conditioner-208/230/1/60 |
| RA1360AJ1NA | Classic® Series 5 ton 13 SEER Single-Stage Air Conditioner-208/230/1/60 |
| RA1318AJ1NB | Classic® Series 1 1/2 ton 13 SEER Single-Stage Air Conditioner w/ High/Low Pressure-208/230/1/60 |
| RA1324AJ1NB | Classic® Series 2 ton 13 SEER Single-Stage Air Conditioner w/ High/Low Pressure-208/230/1/60 |
| RA1330AJ1NB | Classic® Series 2 1/2 ton 13 SEER Single-Stage Air Conditioner w/ High/Low Pressure-208/230/1/60 |
| RA1336AJ1NB | Classic® Series 3 ton 13 SEER Single-Stage Air Conditioner w/ High/Low Pressure-208/230/1/60 |
| RA1342AJ1NB | Classic® Series 3 1/2 ton 13 SEER Single-Stage Air Conditioner w/ High/Low Pressure-208/230/1/60 |
| RA1348AJ1NB | Classic® Series 4 ton 13 SEER Single-Stage Air Conditioner w/ High/Low Pressure-208/230/1/60 |
| RA1360AJ1NB | Classic® Series 5 ton 13 SEER Single-Stage Air Conditioner w/ High/Low Pressure-208/230/1/60 |
| RA1336AC1NB | Classic® Series 3 ton 13 SEER Single-Stage Air Conditioner w/ High/Low Pressure-208/230/3/60 |
| RA1342AC1NB | Classic® Series 3 1/2 ton 13 SEER Single-Stage Air Conditioner w/ High/Low Pressure-208/230/3/60 |
| RA1348AC1NB | Classic® Series 4 ton 13 SEER Single-Stage Air Conditioner w/ High/Low Pressure-208/230/3/60 |
| RA1360AC1NB | Classic® Series 5 ton 13 SEER Single-Stage Air Conditioner w/ High/Low Pressure-208/230/3/60 |
| RA1336AD1NB | Classic® Series 3 ton 13 SEER Single-Stage Air Conditioner w/ High/Low Pressure-460/3/60 |
| RA1342AD1NB | Classic® Series 3 1/2 ton 13 SEER Single-Stage Air Conditioner w/ High/Low Pressure-460/3/60 |
| RA1348AD1NB | Classic® Series 4 ton 13 SEER Single-Stage Air Conditioner w/ High/Low Pressure-460/3/60 |
| RA1360AD1NB | Classic® Series 5 ton 13 SEER Single-Stage Air Conditioner w/ High/Low Pressure-460/3/60 |



Introduction to RA13 Air Conditioner

The RA13 is our 13 SEER air conditioner and is part of the Rheem air conditioner product line that extends from 13 to 20 SEER. This highly featured and reliable air conditioner is designed for years of reliable, efficient operation when matched with Rheem indoor aluminum evaporator coils and furnaces or air handler units with aluminum evaporators.

Our unique composite base (1) reduces sound emission, eliminates rattles, significantly reduces fasteners, eliminates corrosion and has integrated brass compressor attachment inserts (2). Furthermore it has incorporated into the design, water management features, means for hand placement (3) for unit maneuvering, screw trays (4) and inserts for lifting off unit pad. (5)

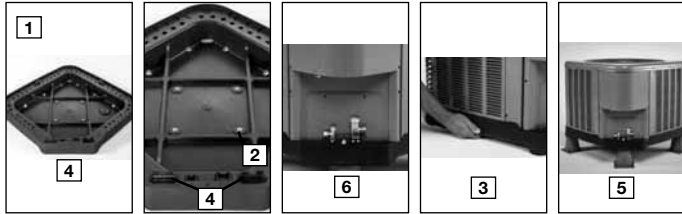

Service Valves (6) are rigidly mounted in the composite base with 3" between suction and discharge valves, 4" clearance below service valves and a minimum of 5" above the service valves, creating industry leading installation ease. The minimum 27 square-inches around the service valves allows ample room to remove service valve schrader prior to brazing, plenty of clearance for easy brazing of the suction and discharge lines to service valve outlets, easy access and hookup of low loss refrigerant gauges (7), and access to the service valve caps for opening. For applications with long-line lengths up to 250 feet total equivalent length, up to 200 feet condenser above evaporator, or up to 80 feet evaporator above condenser, the long-line instructions in the installation manual should be followed.

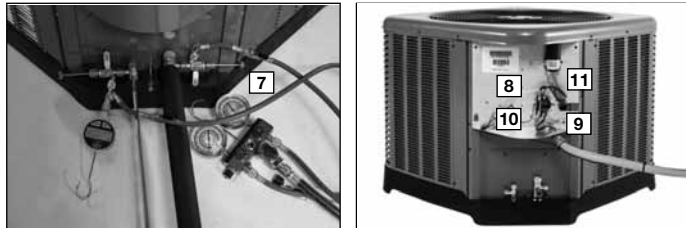

Controls are accessed from the corner of the unit by removing only two fasteners from the control access cover, revealing the industry's largest 15" wide and 14" tall control area (8). With all this room in the control area the high voltage electrical whip (9) can easily be inserted through the right size opening in the bottom of the control area. Routing it leads directly to contractor lugs for connection. The low voltage control wires (10) are easily connected to units low voltage wiring. If contactor or capacitor (11) needs to be replaced there is more than adequate space to make the repair. Furthermore, if high pressure and low pressure model was not purchased but is desired to be installed in the field, the service window (12) can be removed by removing two screws, to access the high and low side schrader fittings for easy field installation. The entire corner can be removed providing ultimate access to install the high and low pressure switch. (13)

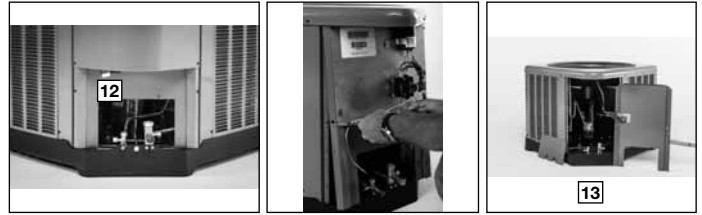

If in the rare event, greater access is needed to internal components, such as the compressor, the entire corner of the unit can be removed along with the top cover assembly to have unprecedented access to interior of the unit (14). Extra wire length is incorporated into each outdoor fan and compressor so top cover and control panel can be positioned next to the unit. With minimal effort the plug can be removed from the compressor and the outdoor fan wires can be removed from the capacitor to allow even more uncluttered access to the interior of the unit (15). Outdoor coil heights range from as short as 22" to 28", aiding access to the compressor. Disassembly to this degree and complete reassembly only takes a first time service technician less than 10 minutes. (15)

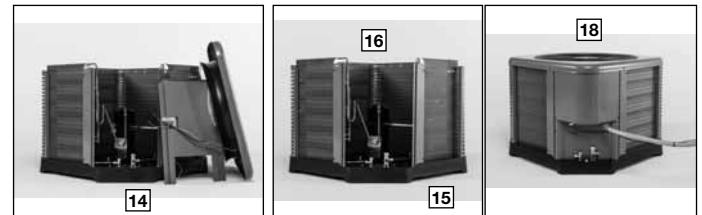

All units utilize strong formed louver panels which provide industry leading coil protection. Louver removal for coil cleaning is accomplished by removing one screw and lifting the panel out of the composite base pan. (17) All RA13 units utilize single row coils (16) making cleaning easy and complete, restoring the performance of the air conditioner back to out of the box performance levels year after year.

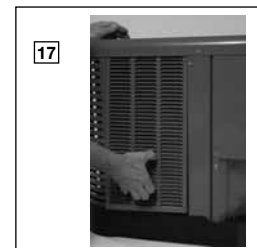

The outdoor fan motor has sleeve bearings and is inherently protected. The motor is totally enclosed for maximum protection from weather, dust and corrosion. Access to the outdoor fan is made by removing four fasteners from the fan grille. The outdoor fan can be removed from the fan grille by removing 4 fasteners in the rare case outdoor fan motor fails.

Each cabinet has optimized composite (19) fan orifice assuring efficient and quiet airflow.



The entire cabinet has powder post paint (20) achieving 1000 hour salt spray rating, allowing the cabinet to retain its aesthetics throughout its life.



Scroll compressors with standard internal pressure relief and internal thermal overload are used on all capacities assuring longevity of high efficient and quiet operation for the life of the product.

Each unit is shipped with filter drier for field installation and will trap any moisture or dirt that could contaminate the refrigerant system.



All cabinets have industry leading structural strength due to the composite base pan (21), interlocking corner post (22), formed curved louver panels (23) and drawn top cover (24) making it the most durable cabinet on the market today.

Each RA13 capacity has undergone rigorous psychometric testing to assure performance ratings of capacity, SEER and EER per AHRI Standard 210/240 rating conditions. Also each unit bears the UL mark and each unit is certified  to UL 1995 safety standards.

Each unit has undergone specific strain and modal testing to assure tubing (25) is outside the units natural frequency and that the suction and discharge lines connected to the compressor withstand any starting, steady state operation or shut down forces imposed by the compressor.

All units have been sound tested in sound chamber to AHRI 270 rating conditions, and A-weighted Sound Power Level tables produced, assuring units have acceptable noise qualities (see page 9). Each unit has been ran in cooling operation at 95°F and 82°F and sound ratings for the RA13 range from as low as 73 dBA to 79 dBA.

All units have been ship tested to assure units meet stringent “over the road” shipping conditions.

As manufactured all units in the RA13 family have cooling capability to 55 °F. Addition of low ambient control will allow the unit to operate down to 0°F. Factory testing is performed on each unit. All component parts meet well defined specification and continually go through receiving inspections. Each component installed on a unit is scanned, assuring correct component utilization for a given unit capacity and voltage. All condenser coils are leak tested with pressurization test to 550#’s and once installed and assembled, each units’ complete refrigerant system is helium leak tested. All units are fully charged from the factory for up to 15 feet of piping. All units are factory run tested. The RA13 has a 10-year conditional compressor and parts warranty (registration required).

Optional Accessories (Refer to accessory chart for model #)

Compressor Crankcase Heater

Protects against refrigerant migration that can occur during low ambient operation

Compressor Sound Cover

- Reinforced vinyl compressor cover containing a 1½ inch thick batt of fiberglass insulation
- Open edges are sealed with a one-inch wide hook and loop fastening tape

Compressor Hard Start Kit

- Single-phase units are equipped with a PSC compressor motor, this type of motor normally does not need a potential relay and start capacitor
- Kit may be required to increase the compressor starting torque, in conditions such as low voltage

Low Ambient Kit

- Air conditioners operate satisfactorily in the cooling mode down to 55°F outdoor air temperature without any additional controls
- This Kit can be added in the field enabling unit to operate properly down to 0° in the cooling mode
- Crankcase heater and freezestat should be installed on compressors equipped with a low ambient kit

3"/6"/12"

- Gray high density polyethylene feet are available to raise unit off of mounting surface away from moisture

Low Pressure

- Can be added in field enabling the unit to shut off compressor on loss of charge

NOTE: Unit can be purchased with high and low pressure installed at factory. (Refer to SKU list)

High Pressure

- Can be added in field enabling unit to shut off compressor if unit loses outdoor fan operation.

NOTE: Unit can be purchased with high and low pressure installed at factory. (Refer to SKU list)

Decorative Top

- Can be installed on fan grille



Air Conditioners*

R A 13 24 A J 1 N A * -

| Brand | Product Category | SEER | Capacity BTU/HR | Major Series* | Voltage | Type | Controls | Minor Series** | Option Code |
|-------|----------------------|--|---|----------------|---|---|--|----------------|-------------|
| Rheem | A - Air Conditioners | 13 - 13 SEER 14 - 14 SEER 16 - 16 SEER 17 - 17 SEER 20 - 20 SEER | 18 - 18,000 [5.28 kW] 24 - 24,000 [7.03 kW] 30 - 30,000 [8.79 kW] 36 - 36,000 [10.55 kW] 42 - 42,000 [12.31 kW] 48 - 48,000 [14.07 kW] 60 - 60,000 [17.58 kW] | A - 1st Design | J - 1ph, 208-230/60 C - 3ph, 208-230/60 D - 3ph, 460/60 | 1 - Single-stage 2 - Two-stage V - Inverter | C - Communicating N - Non-Communicating | A - 1st Design | N/A |

*See page 3 for available SKU's.

Heat Pumps (For Reference)**

R P 14 24 A J 1 N A * -

| Brand | Product Category | SEER | Capacity BTU/HR | Major Series* | Voltage | Type | Controls | Minor Series** | Option Code |
|-------|------------------|--|---|----------------|---|---|--|----------------|-------------|
| Rheem | P - Heat Pump | 13 - 13 SEER 14 - 14 SEER 15 - 15 SEER 17 - 17 SEER 20 - 20 SEER | 18 - 18,000 [5.28 kW] 24 - 24,000 [7.03 kW] 30 - 30,000 [8.79 kW] 36 - 36,000 [10.55 kW] 42 - 42,000 [12.31 kW] 48 - 48,000 [14.07 kW] 60 - 60,000 [17.58 kW] | A - 1st Design | J - 1ph, 208-230/60 C - 3ph, 208-230/60 D - 3ph, 460/60 | 1 - Single-stage 2 - Two-stage V - Inverter P - Piston | C - Communicating N - Non-Communicating | A - 1st Design | N/A |

Furnace Coils (For Reference)**

R C F 17 24 S I A M C A * -

| Brand | Product Category | Type | Capacity BTU/HR | Width | Efficiency | Metering Device | Major Series* | Orientation | Casing | Minor Series** | Option Code |
|-------|------------------|--|---|--|--|----------------------------|----------------|--|--------------------------|----------------|-------------|
| Rheem | C - Evap Coil | F - Furn Coil H - Air-Handler Coil | 24 - 24,000 [7.03 kW] 36 - 36,000 [10.55 kW] 48 - 48,000 [14.07 kW] 60 - 60,000 [17.58 kW] | 14 - 14" 17 - 17.5" 21 - 21" 24 - 24.5" | S - Standard Eff. M - Mid Eff. H - High Eff. | T-TXV E-EEV P-Piston | A - 1st Design | M - Multipoise V - Vertical only/ convertible H - Ded. Horizontal only | C - Cased U - Uncased | A - 1st Design | N/A |

**Model number ID's are for reference only. See available SKU page of applicable spec sheet for table of available SKU's for a specific model.

[] Designates Metric Conversions



90%+ AFUE Gas Furnaces (For Reference)**

| R | 96 | V | A | 70 | 2 | 3 | 17 | M | S | A |
|-------|--------------|----------------------------|----------------|--------------------------|------------------|-----------------------|---------------|---------------|--------------|----------------|
| Brand | Series | Motor | Major Rev | Input BTU/HR | Stages | Air Flow | Cabinet Width | Configuration | Nox | Minor Rev |
| Rheem | 90 - 90 AFUE | V - Variable speed | A - 1st Design | 040 - 42,000 [12.31 kW] | 1 - Single-stage | 3 - up to 3 ton | 14 - 14" | M - Multi | X - Low Nox | A - 1st Design |
| | 92 - 92 AFUE | T - Constant Torque (X-13) | | 060 - 56,000 [16.41 kW] | 2 - Two-stage | 5 - 3 1/2 up to 5 ton | 17 - 17.5" | | S - Standard | |
| | 95 - 95 AFUE | | | 070 - 70,000 [20.51 kW] | M - Modulating | | 21 - 21" | | | |
| | 96 - 96 AFUE | | | 085 - 84,000 [24.62 kW] | | | 24 - 24.5" | | | |
| | 97 - 97 AFUE | P - PSC | | 100 - 98,000 [28.72 kW] | | | | | | |
| | | | | 115 - 112,000 [32.82 kW] | | | | | | |

80% AFUE Gas Furnaces (For Reference)**

| R | 80 | 2 | V | A | 075 | 3 | 17 | M | S | A |
|-------|---------------|------------------|----------------------------|----------------|-----------------------|-----------------------|---------------|---------------------------|--------------|----------------|
| Brand | Series | Stages | Motor | Major Rev | Input BTU/HR | Air Flow | Cabinet Width | Configuration | Nox | Minor Rev |
| Rheem | 80 - 80+ AFUE | 1 - Single-stage | V - Variable speed | A - 1st Design | 050 - 50,000 [15 kW] | 3 - up to 3 ton | 14 - 14" | M - Multi | X - Low Nox | A - 1st Design |
| | | 2 - Two-stage | T - Constant Torque (X-13) | | 075 - 75,000 [22 kW] | 4 - 2 1/2 to 4 ton | 17 - 17.5" | D - Down | S - Standard | |
| | | | P - PSC premium | | 100 - 100,000 [29 kW] | 5 - 3 1/2 up to 5 ton | 21 - 21" | Z - Down & zero clearance | | |
| | | | S - PSC standard | | 125 - 125,000 [37 kW] | | 24 - 24.5" | down flow | | |
| | | | | | 150 - 150,000 [44 kW] | | | | | |

Air Handlers (For Reference)**

| R | H | 1 | I | 36 | 17 | S | T | A | N | A | * | |
|-------|------------------|-------------------|---------------------|------------------------|------------|-------------------|-----------------|----------------|-------------------|---------------------|----------------|-------------------------------|
| Brand | Product Category | Stages of Airflow | Motor Type | Capacity BTU/HR | Width | Coil Size | Metering Device | Major Series* | Controls | Voltage | Minor Series** | Factory Heat Option Code |
| Rheem | H - Air Handler | 1 - Single-Stage | V - Variable Speed | 24 - 24,000 [7.03 kW] | 14 - 14" | S - Standard Eff. | T - TEV | A - 1st Design | C - Communicating | A - 1ph, 115/60 | A - 1st Design | 00 - no |
| | | 2 - Two-Stage | T - Constant Torque | 36 - 36,000 [10.55 kW] | 17 - 17.5" | M - Mid Eff. | E - EEV | N - Non-comm | N - Non-comm | J - 1ph, 208-240/60 | A - 1st Design | factory heat with option code |
| | | M - Modulating | P - PSC | 48 - 48,000 [14.07 kW] | 21 - 21" | H - High Eff. | P - Piston | | D - 3ph, 480/60 | D - 3ph, 480/60 | | |
| | | | | 60 - 60,000 [17.58 kW] | 24 - 24.5" | | | | | | | |

**Model number ID's are for reference only. See available SKU page of applicable spec sheet for table of available SKU's for a specific model.

[] Designates Metric Conversions



Physical Data

| PHYSICAL DATA | | | | | | | |
|--|---------|---------|---------|---------|---------|---------|---------|
| Model No. | RA1318A | RA1324A | RA1330A | RA1336A | RA1342A | RA1348A | RA1360A |
| Nominal Tonnage | 1.5 | 2.0 | 2.5 | 3.0 | 3.5 | 4.0 | 5.0 |
| Valve Connections | | | | | | | |
| Liquid Line O.D. – in. | 3/8 | 3/8 | 3/8 | 3/8 | 3/8 | 3/8 | 3/8 |
| Suction Line O.D. – in. | 3/4 | 3/4 | 3/4 | 3/4 | 7/8 | 7/8 | 7/8 |
| Refrigerant (R410A) furnished oz. ¹ | 50 | 60 | 72 | 86 | 105 | 106 | 148 |
| Compressor Type | Scroll | | | | | | |
| Outdoor Coil | | | | | | | |
| Net face area – Outer Coil | 5.9 | 9.1 | 9.1 | 12.1 | 14.2 | 14.8 | 18.8 |
| Net face area – Inner Coil | — | — | — | — | — | — | — |
| Tube diameter – in. | 3/8 | 3/8 | 3/8 | 3/8 | 3/8 | 3/8 | 3/8 |
| Number of rows | 1 | 1 | 1 | 1 | 1 | 1 | 1 |
| Fins per inch | 22 | 18 | 22 | 22 | 22 | 22 | 22 |
| Outdoor Fan | | | | | | | |
| Diameter – in. | 20 | 20 | 20 | 20 | 20 | 24 | 26 |
| Number of blades | 2 | 2 | 3 | 3 | 2 | 3 | 2 |
| Motor hp | 1/8 | 1/8 | 1/4 | 1/4 | 1/8 | 1/6 | 1/5 |
| CFM | 2038 | 2325 | 2795 | 2900 | 2465 | 4145 | 3870 |
| RPM | 1075 | 1075 | 1075 | 1075 | 1075 | 850 | 820 |
| watts | 144 | 137 | 189 | 186 | 175 | 279 | 233 |
| Shipping weight – lbs. | 127 | 129 | 140 | 164 | 195 | 202 | 235 |
| Operating weight – lbs. | 120 | 122 | 133 | 157 | 188 | 195 | 228 |

Electrical Data

| | | | | | | | |
|--|---------------------|---------------------|---------------------|---------------------|---------------------|---------------------|---------------------|
| Line Voltage Data (Volts-Phase-Hz) | 208/230-1-60 | 208/230-1-60 | 208/230-1-60 | 208/230-1-60 | 208/230-1-60 | 208/230-1-60 | 208/230-1-60 |
| Maximum overcurrent protection (amps) ² | 20 | 25 | 30 | 35 | 40 | 50 | 60 |
| Minimum circuit ampacity ³ | 13 | 15 | 18 | 23 | 24 | 29 | 35 |
| Compressor | | | | | | | |
| Rated load amps | 9.7 | 11.2 | 12.8 | 16.7 | 17.9 | 21.8 | 26.4 |
| Locked rotor amps | 46 | 60.8 | 64 | 83.9 | 112 | 117 | 134 |
| Condenser Fan Motor | | | | | | | |
| Full load amps | 0.7 | 0.7 | 1.3 | 1.3 | 0.7 | 1 | 1.2 |
| Locked rotor amps | 1.3 | 1.3 | 2.5 | 2.6 | 1.3 | 2.2 | 2.0 |
| Line Voltage Data (Volts-Phase-Hz) | — | — | — | 208/230-3-60 | 208/230-3-60 | 208/230-3-60 | 208/230-3-60 |
| Maximum overcurrent protection (amps) ² | — | — | — | 20 | 30 | 30 | 35 |
| Minimum circuit ampacity ³ | — | — | — | 15 | 18 | 19 | 22 |
| Compressor | | | | | | | |
| Rated load amps | — | — | — | 10.4 | 13.2 | 13.7 | 16 |
| Locked rotor amps | — | — | — | 73 | 88 | 83.1 | 110 |
| Condenser Fan Motor | | | | | | | |
| Full load amps | — | — | — | 1.3 | 0.7 | 1 | 1.3 |
| Locked rotor amps | — | — | — | 2.6 | 1.3 | 2.2 | 2.0 |
| Line Voltage Data (Volts-Phase-Hz) | — | — | — | 480-3-60 | 480-3-60 | 480-3-60 | 480-3-60 |
| Maximum overcurrent protection (amps) ² | — | — | — | 15 | 15 | 15 | 15 |
| Minimum circuit ampacity ³ | — | — | — | 8 | 8 | 9 | 11 |
| Compressor | | | | | | | |
| Rated load amps | — | — | — | 5.8 | 6.0 | 6.2 | 7.8 |
| Locked rotor amps | — | — | — | 38 | 44 | 41 | 52 |
| Condenser Fan Motor | | | | | | | |
| Full load amps | — | — | — | .6 | .3 | .6 | .6 |
| Locked rotor amps | — | — | — | 2.5 | .9 | 1.6 | 1.1 |

¹Refrigerant charge sufficient for 15 ft. length of refrigerant lines. For longer line set requirements see the installation instructions for information about set length and additional refrigerant charge required.

²HACR type circuit breaker or fuse.

³Refer to National Electrical Code manual to determine wire, fuse and disconnect size requirements.



Accessories

| Model No. | RA1318 | RA1324 | RA1330 | RA1336 | RA1342 | RA1348 | RA1360 |
|---|----------------|----------------|----------------|----------------|----------------|----------------|----------------|
| Compressor crankcase heater* | 44-17402-44 | 44-17402-44 | 44-17402-44 | 44-17402-44 | 44-17402-45 | 44-17402-45 | 44-17402-45 |
| Low ambient control | RXAD-A08 | RXAD-A08 | RXAD-A08 | RXAD-A08 | RXAD-A08 | RXAD-A08 | RXAD-A08 |
| Compressor sound cover | 68-23427-26 | 68-23427-26 | 68-23427-26 | 68-23427-26 | 68-23427-25 | 68-23427-25 | 68-23427-25 |
| Compressor hard start kit | SK-A1 | SK-A1 | SK-A1 | SK-A1 | SK-A1 | SK-A1 | SK-A1 |
| Compressor time delay | RXMD-B01 | RXMD-B01 | RXMD-B01 | RXMD-B01 | RXMD-B01 | RXMD-B01 | RXMD-B01 |
| Low pressure control | RXAC-A07 | RXAC-A07 | RXAC-A07 | RXAC-A07 | RXAC-A07 | RXAC-A07 | RXAC-A07 |
| High pressure control | RXAB-A07 | RXAB-A07 | RXAB-A07 | RXAB-A07 | RXAB-A07 | RXAB-A07 | RXAB-A07 |
| Liquid Line Solenoid (24 VAC, 50/60 Hz) | Solenoid Valve | 200RD2T3TVLC | 200RD2T3TVLC | 200RD2T3TVLC | 200RD2T3TVLC | 200RD2T3TVLC | 200RD2T3TVLC |
| | Solenoid Coil | 61-AMG24V | 61-AMG24V | 61-AMG24V | 61-AMG24V | 61-AMG24V | 61-AMG24V |
| Liquid Line Solenoid (120/240 VAC, 50/60 Hz) | Solenoid Valve | 200RD2T3TVLC | 200RD2T3TVLC | 200RD2T3TVLC | 200RD2T3TVLC | 200RD2T3TVLC | 200RD2T3TVLC |
| | Solenoid Coil | 61-AMG120/240V | 61-AMG120/240V | 61-AMG120/240V | 61-AMG120/240V | 61-AMG120/240V | 61-AMG120/240V |
| Top Cap w/Label | 91-101123-21 | 91-101123-21 | 91-101123-21 | 91-101123-21 | 91-101123-21 | 91-101123-21 | 91-101123-21 |
| Heat Pump Riser 6 in. | 686020 | 686020 | 686020 | 686020 | 686020 | 686020 | 686020 |

*Crankcase Heater recommended with Low Ambient Kit.

Weighted Sound Power Level (dBA)

| Model | Sound Power Level [dB(A)] | RA13 Sound Power Level | | | | | | | |
|--------|---------------------------|---|------|------|------|------|------|------|------|
| | | Full Octave Linear Sound Power Level dB - Center Frequency - Hz | | | | | | | |
| | | 125 | 250 | 500 | 1000 | 2000 | 4000 | 6300 | 8000 |
| RA1318 | 71.9 | 52.1 | 58.3 | 61.5 | 61.1 | 57.0 | 54.2 | 51.0 | 48.7 |
| RA1324 | 75.5 | 55.4 | 60.3 | 64.7 | 66.4 | 62.6 | 58.0 | 54.3 | 52.4 |
| RA1330 | 73.6 | 49.7 | 62.6 | 64.6 | 63.1 | 60.3 | 54.8 | 49.4 | 47.6 |
| RA1336 | 72.4 | 55.1 | 60.2 | 62.6 | 63.3 | 58.1 | 53.4 | 51.3 | 52.0 |
| RA1342 | 72.7 | 48.9 | 56.1 | 62.9 | 62.2 | 61.1 | 55.2 | 51.9 | 50.2 |
| RA1348 | 75.8 | 51.4 | 59.6 | 65.2 | 65.9 | 64.3 | 58.5 | 55.2 | 53.7 |
| RA1360 | 77.7 | 51.7 | 60.9 | 66.9 | 70.4 | 63.5 | 57.4 | 55.4 | 53.8 |

NOTE: Tested in accordance with AHRI Standard 270-08 (not listed in AHRI)

Thermostats



200-Series *
Programmable



300-Series *
Deluxe
Programmable

400-Series *
Special Applications/
Programmable



500-Series *
Communicating/
Programmable

| Brand | Descriptor (3 Characters) | Series (3 Characters) | System (2 Characters) | Type (2 Characters) |
|-----------|------------------------------|--|---|-----------------------------------|
| RHC | TST | 213 | UN | MS |
| RHC=Rheem | TST=Thermostat | 200=Programmable 300=Deluxe Programmable 400=Special Applications/ Programmable 500=Communicating/ Programmable | GE=Gas/Electric UN=Universal (AC/HP/GE) MD=Modulating Furnace DF=Dual Fuel CM=Communicating | SS=Single-Stage MS=Multi-Stage |

* Photos are representative. Actual models may vary.

For detailed thermostat match-up information,
see specification sheet form number T11-001.

Unit Dimensions

| MODEL NO. | OPERATING | | | | | | SHIPPING | | | | | |
|-----------|------------|-----|------------|-----|-----------|-----|------------|-----|------------|-----|-----------|-----|
| | H (Height) | | L (Length) | | W (Width) | | H (Height) | | L (Length) | | W (Width) | |
| | INCHES | mm | INCHES | mm | INCHES | mm | INCHES | mm | INCHES | mm | INCHES | mm |
| RA1318 | 27 | 685 | 29.75 | 755 | 29.75 | 755 | 28.75 | 730 | 32.38 | 822 | 32.38 | 822 |
| RA1324 | 25 | 635 | 29.75 | 755 | 29.75 | 755 | 26.75 | 679 | 32.38 | 822 | 32.38 | 822 |
| RA1330 | 25 | 635 | 29.75 | 755 | 29.75 | 755 | 26.75 | 679 | 32.38 | 822 | 32.38 | 822 |
| RA1336 | 27 | 685 | 29.75 | 755 | 29.75 | 755 | 28.75 | 730 | 32.38 | 822 | 32.38 | 822 |
| RA1342 | 31 | 787 | 29.75 | 755 | 29.75 | 755 | 32.75 | 831 | 32.38 | 822 | 32.38 | 822 |
| RA1348 | 27 | 685 | 33.75 | 857 | 33.75 | 857 | 28.75 | 730 | 36.38 | 924 | 36.38 | 924 |
| RA1360 | 31 | 787 | 35.75 | 908 | 35.75 | 908 | 32.75 | 831 | 38.38 | 974 | 38.38 | 974 |

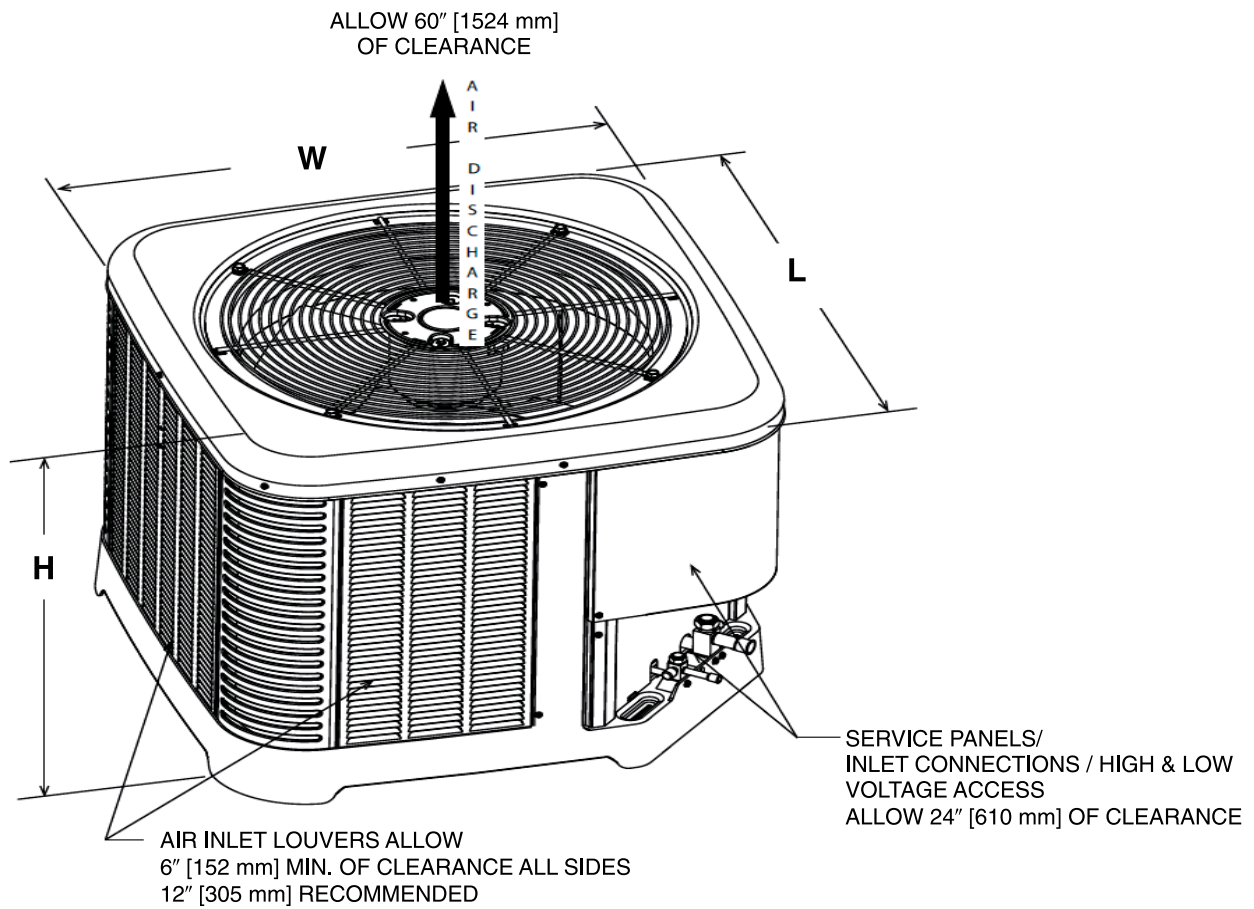

[] Designates Metric Conversions

ST-A1226-02-00

CLEARANCES

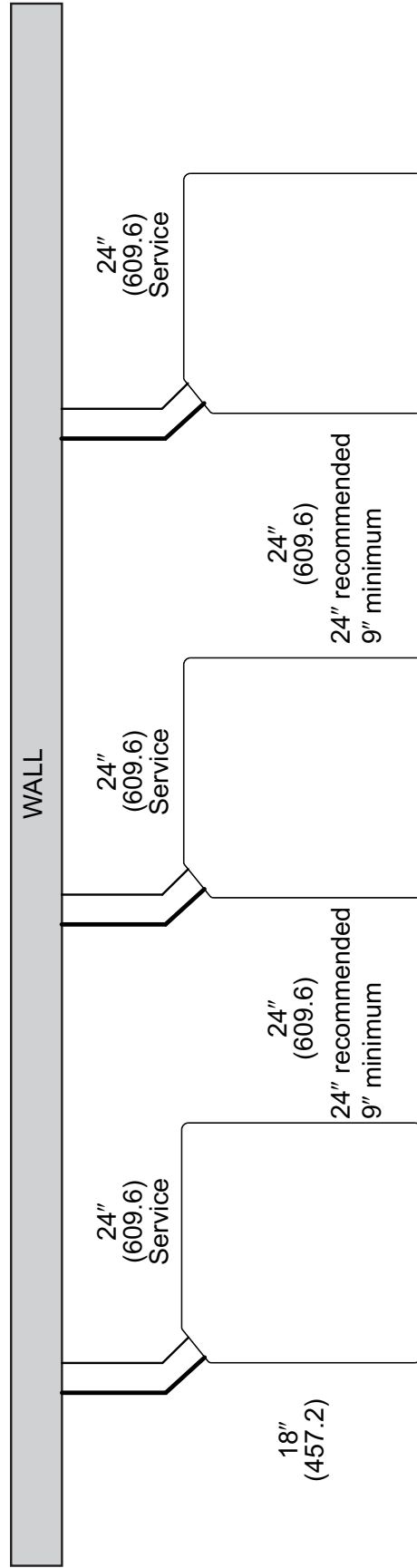
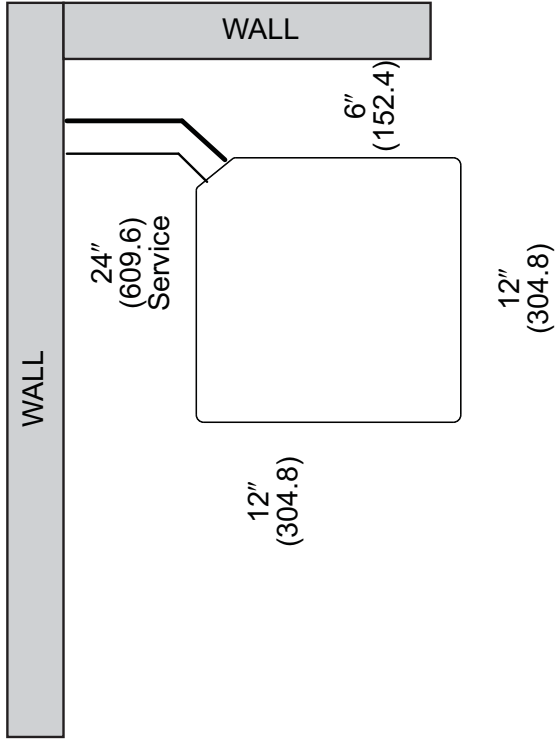
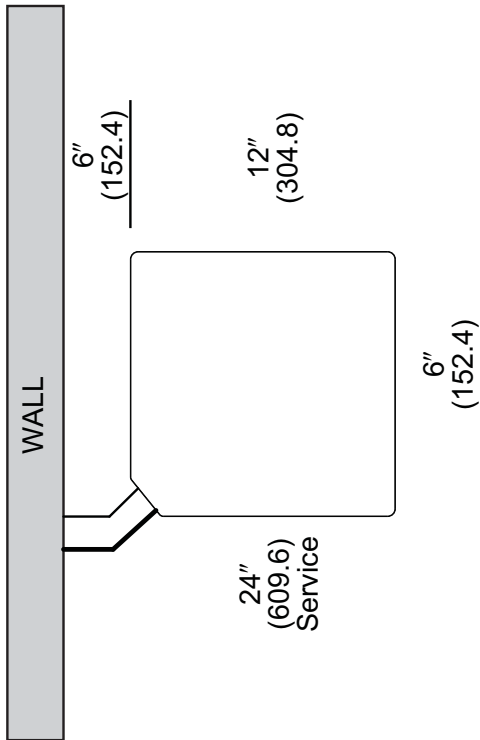

NOTE: NUMBERS IN () = mm

IMPORTANT: When installing multiple units in an alcove, roof well or partially enclosed area, ensure there is adequate ventilation to prevent re-circulation of discharge air.

Control Wiring

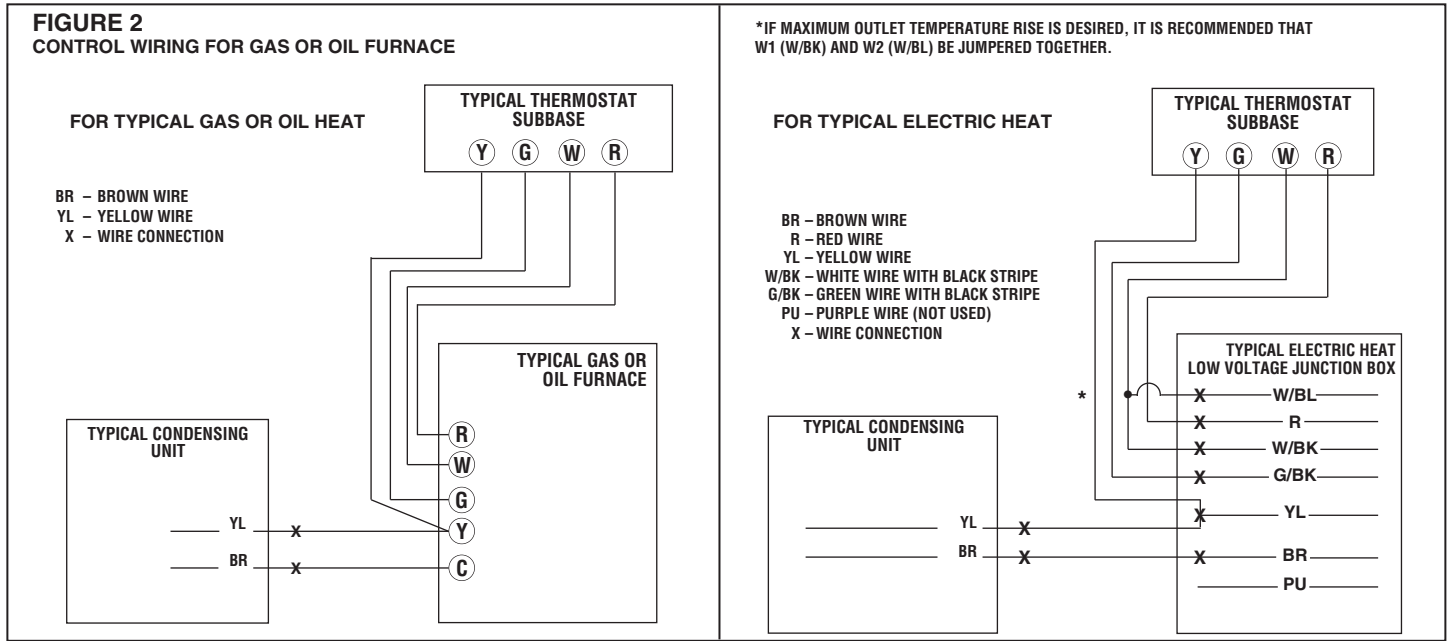

Application Guidelines

1. Intended for outdoor installation with free air inlet and outlet. Outdoor fan external static pressure available is less than 0.01 -in. wc.
2. Minimum outdoor operation air temperature for cooling mode without low-ambient operation accessory is 55°F (12.8°C).
3. Maximum outdoor operating air temperature is 125°F (51.7°C).
4. For reliable operation, unit should be level in all horizontal planes.
5. Use only copper wire for electric connections at unit. Aluminum and clad aluminum are not acceptable for the type of connector provided.
6. Do not apply capillary tube indoor coils to these units.
7. Factory – supplied filter drier must be installed.



Air

Refrigerant Line Size Information (con't.)

| R-410A System Capacity Model | Vapor Line Connection Size (Inch I.D.) [mm] | Vapor Line Size (Inch O.D.) [mm] | Vapor Line Selection Chart Capacity Multiplier Table | | | | | | | | | | | | | | | |
|------------------------------|---|----------------------------------|--|------------|------------|-------------|-------------|-------------|-------------|-------------|-------------|-------------|-------------|-------------|------|------|------|------|
| | | | Total Equivalent Length - Feet [m] | | | | | | | | | | | | | | | |
| | | | 25 [7.62] | 50 [15.24] | 75 [22.86] | 100 [30.48] | 125 [45.72] | 150 [45.72] | 175 [53.34] | 200 [60.96] | 225 [68.58] | 250 [76.20] | 275 [83.82] | 300 [91.44] | | | | |
| 18 | 3/4" [19.06] | 5/8 [15.88] | 1.00 | 0.99 | 0.99 | 0.98 | 0.98 | 0.98 | 0.98 | 0.97 | 0.97 | 0.97 | 0.97 | 0.96 | 0.96 | 0.96 | 0.95 | |
| | | | 1.00 | 1.00 | 1.00 | 1.00 | 1.00 | 1.00 | 0.99 | 0.99 | 0.99 | 0.99 | 0.99 | 0.99 | 0.99 | 0.99 | 0.99 | |
| | | | N/R | N/R | N/R | N/R | N/R | N/R | N/R | N/R | N/R | N/R | N/R | N/R | N/R | N/R | N/R | N/R |
| | | | N/R | N/R | N/R | N/R | N/R | N/R | N/R | N/R | N/R | N/R | N/R | N/R | N/R | N/R | N/R | N/R |
| | | | N/R | N/R | N/R | N/R | N/R | N/R | N/R | N/R | N/R | N/R | N/R | N/R | N/R | N/R | N/R | N/R |
| 24 | 3/4" [19.06] | 5/8 [15.88] | 1.00 | 0.99 | 0.99 | 0.98 | 0.98 | 0.98 | 0.98 | 0.97 | 0.97 | 0.97 | 0.97 | 0.96 | 0.96 | 0.96 | 0.95 | |
| | | | 1.00 | 1.00 | 1.00 | 1.00 | 1.00 | 1.00 | 1.00 | 0.99 | 0.99 | 0.99 | 0.99 | 0.99 | 0.99 | 0.99 | 0.99 | |
| | | | 1.00 | 1.00 | 1.00 | 1.00 | 1.00 | 1.00 | 1.00 | 1.00 | 1.00 | 1.00 | 1.00 | 1.00 | 1.00 | 1.00 | 1.00 | 1.00 |
| | | | N/R | N/R | N/R | N/R | N/R | N/R | N/R | N/R | N/R | N/R | N/R | N/R | N/R | N/R | N/R | N/R |
| | | | N/R | N/R | N/R | N/R | N/R | N/R | N/R | N/R | N/R | N/R | N/R | N/R | N/R | N/R | N/R | N/R |
| 30 | 3/4" [19.06] | 5/8 [15.88] | 1.00 | 0.99 | 0.99 | 0.98 | 0.98 | 0.98 | 0.98 | 0.97 | 0.97 | 0.97 | 0.97 | 0.96 | 0.96 | 0.96 | 0.95 | |
| | | | 1.00 | 1.00 | 1.00 | 1.00 | 1.00 | 1.00 | 1.00 | 0.99 | 0.99 | 0.99 | 0.99 | 0.99 | 0.99 | 0.99 | 0.99 | |
| | | | 1.00 | 1.00 | 1.00 | 1.00 | 1.00 | 1.00 | 1.00 | 1.00 | 1.00 | 1.00 | 1.00 | 1.00 | 1.00 | 1.00 | 1.00 | 1.00 |
| | | | N/R | N/R | N/R | N/R | N/R | N/R | N/R | N/R | N/R | N/R | N/R | N/R | N/R | N/R | N/R | N/R |
| | | | N/R | N/R | N/R | N/R | N/R | N/R | N/R | N/R | N/R | N/R | N/R | N/R | N/R | N/R | N/R | N/R |
| 36 | 3/4" [19.06] | 5/8 [15.88] | 1.00 | 0.99 | 0.99 | 0.98 | 0.98 | 0.98 | 0.98 | 0.97 | 0.97 | 0.97 | 0.97 | 0.96 | 0.96 | 0.96 | 0.95 | |
| | | | 1.00 | 1.00 | 1.00 | 1.00 | 1.00 | 1.00 | 1.00 | 0.99 | 0.99 | 0.99 | 0.99 | 0.99 | 0.99 | 0.99 | 0.99 | |
| | | | 1.00 | 1.00 | 1.00 | 1.00 | 1.00 | 1.00 | 1.00 | 1.00 | 1.00 | 1.00 | 1.00 | 1.00 | 1.00 | 1.00 | 1.00 | 1.00 |
| | | | N/R | N/R | N/R | N/R | N/R | N/R | N/R | N/R | N/R | N/R | N/R | N/R | N/R | N/R | N/R | N/R |
| | | | N/R | N/R | N/R | N/R | N/R | N/R | N/R | N/R | N/R | N/R | N/R | N/R | N/R | N/R | N/R | N/R |
| 42 | 7/8" [22.23] | 1 [25.4] | 1.00 | 1.00 | 1.00 | 1.00 | 1.00 | 1.00 | 1.00 | 1.00 | 1.00 | 1.00 | 1.00 | 1.00 | 1.00 | 1.00 | 1.01 | |
| | | | 1.00 | 1.00 | 1.00 | 1.00 | 1.00 | 1.00 | 1.00 | 1.00 | 1.00 | 1.00 | 1.00 | 1.00 | 1.00 | 1.00 | 1.00 | 1.01 |
| | | | 1.00 | 1.00 | 1.00 | 1.00 | 1.00 | 1.00 | 1.00 | 1.00 | 1.00 | 1.00 | 1.00 | 1.00 | 1.00 | 1.00 | 1.00 | 1.01 |
| | | | 1.00 | 1.00 | 1.00 | 1.00 | 1.00 | 1.00 | 1.00 | 1.00 | 1.00 | 1.00 | 1.00 | 1.00 | 1.00 | 1.00 | 1.00 | 1.01 |
| | | | 1.00 | 1.00 | 1.00 | 1.00 | 1.00 | 1.00 | 1.00 | 1.00 | 1.00 | 1.00 | 1.00 | 1.00 | 1.00 | 1.00 | 1.00 | 1.01 |
| 48 | 7/8" [22.23] | 1-1/8 [28.58] | 1.00 | 0.99 | 0.99 | 0.98 | 0.98 | 0.98 | 0.98 | 0.97 | 0.97 | 0.97 | 0.97 | 0.96 | 0.96 | 0.96 | N/R | |
| | | | 1.00 | 1.00 | 1.00 | 1.00 | 1.00 | 1.00 | 1.00 | 0.99 | 0.99 | 0.99 | 0.99 | 0.99 | 0.99 | 0.99 | N/R | |
| | | | 1.00 | 1.00 | 1.00 | 1.00 | 1.00 | 1.00 | 1.00 | 1.00 | 1.00 | 1.00 | 1.00 | 1.00 | 1.00 | 1.00 | 1.00 | N/R |
| | | | 1.00 | 1.00 | 1.00 | 1.00 | 1.00 | 1.00 | 1.00 | 1.00 | 1.00 | 1.00 | 1.00 | 1.00 | 1.00 | 1.00 | 1.00 | N/R |
| | | | 1.00 | 1.00 | 1.00 | 1.00 | 1.00 | 1.00 | 1.00 | 1.00 | 1.00 | 1.00 | 1.00 | 1.00 | 1.00 | 1.00 | 1.00 | N/R |
| 60 | 7/8" [22.23] | 1-1/8 [28.58] | 1.00 | 0.99 | 0.99 | 0.98 | 0.98 | 0.98 | 0.98 | 0.97 | 0.97 | 0.97 | 0.97 | 0.96 | 0.96 | 0.96 | N/R | |
| | | | 1.00 | 1.00 | 1.00 | 1.00 | 1.00 | 1.00 | 1.00 | 0.99 | 0.99 | 0.99 | 0.99 | 0.99 | 0.99 | 0.99 | N/R | |
| | | | 1.00 | 1.00 | 1.00 | 1.00 | 1.00 | 1.00 | 1.00 | 1.00 | 1.00 | 1.00 | 1.00 | 1.00 | 1.00 | 1.00 | 1.00 | N/R |
| | | | 1.00 | 1.00 | 1.00 | 1.00 | 1.00 | 1.00 | 1.00 | 1.00 | 1.00 | 1.00 | 1.00 | 1.00 | 1.00 | 1.00 | 1.00 | N/R |
| | | | 1.00 | 1.00 | 1.00 | 1.00 | 1.00 | 1.00 | 1.00 | 1.00 | 1.00 | 1.00 | 1.00 | 1.00 | 1.00 | 1.00 | 1.00 | N/R |

NOTES:
 N/R = Application not recommended.
 All calculations assume a 3/8" liquid line

[] Designates Metric Conversions

Performance Data @ AHRI Standard Conditions – Cooling

| High Sales Volume Tested Combination (HSVTC) | | | | | | | | |
|--|-------------|------------------------------|----------------------------|--------------------------|------|-----|---------------------|---------|
| Outdoor Unit | Indoor Coil | Total Capacity BTU/H [kW] | Net Sensible BTU/H [kW] | Net Latent BTU/H [kW] | SEER | EER | Indoor CFM [L/s] | AHRI# |
| RA1318AJ1 | RCF2417STAM | 17600 [5.2] | 13100 [3.8] | 4500 [1.3] | 13 | 11 | 600 [283.2] | 7507439 |
| RA1324AJ1 | RCF2417STAM | 23600 [6.9] | 17600 [5.2] | 6000 [1.8] | 13 | 11 | 800 [377.6] | 7507649 |
| RA1330AJ1 | RCF3617STAM | 28400 [8.3] | 21600 [6.3] | 6800 [2.0] | 13 | 11 | 1000 [471.9] | 7507846 |
| RA1336AC1 | RCF3617STAM | 34600 [10.1] | 24500 [7.2] | 10100 [3.0] | 13 | 11 | 1025 [483.7] | 7508191 |
| RA1336AJ1 | RCF3617STAM | 34600 [10.1] | 24500 [7.2] | 10100 [3.0] | 13 | 11 | 1025 [483.7] | 7508557 |
| RA1342AC1 | RCF4821STAM | 40500 [11.9] | 30300 [8.9] | 10200 [3.0] | 13 | 11 | 1400 [660.7] | 7511558 |
| RA1342AJ1 | RCF4821STAM | 40500 [11.9] | 30300 [8.9] | 10200 [3.0] | 13 | 11 | 1400 [660.7] | 7511792 |
| RA1348AC1 | RCF4821STAM | 47500 [13.9] | 34100 [10.0] | 13400 [3.9] | 13 | 11 | 1500 [707.9] | 7508923 |
| RA1348AJ1 | RCF4821STAM | 47500 [13.9] | 34100 [10.0] | 13400 [3.9] | 13 | 11 | 1500 [707.9] | 7509148 |
| RA1360AC1 | RCF6024STAM | 56000 [16.4] | 39600 [11.6] | 16400 [4.8] | 13 | 11 | 1600 [755.1] | 7509314 |
| RA1360AJ1 | RCF6024STAM | 56000 [16.4] | 39600 [11.6] | 16400 [4.8] | 13 | 11 | 1600 [755.1] | 7509436 |

[] Designates Metric Conversions

Performance Data @ AHRI Standard Conditions – Cooling (con't.)

| Coil Only Ratings | | | | | | | | |
|-------------------|----------------------|------------------------------|----------------------------|--------------------------|------|------|---------------------|---------|
| Outdoor Unit | Indoor Coil | Total Capacity BTU/H [kW] | Net Sensible BTU/H [kW] | Net Latent BTU/H [kW] | SEER | EER | Indoor CFM [L/s] | AHRI# |
| RA1318AJ1 | RCF2414STAM+RXMD-C04 | 17600 [5.2] | 12600 [3.7] | 5000 [1.5] | 13 | 11 | 600 [283.2] | 7507408 |
| | RCF2417HTAM+RXMD-C04 | 17500 [5.1] | 12300 [3.6] | 5200 [1.5] | 13 | 11 | 600 [283.2] | 7507423 |
| | RCF2417MTAM+RXMD-C04 | 17500 [5.1] | 12300 [3.6] | 5200 [1.5] | 13 | 11 | 600 [283.2] | 7507438 |
| | RCF2421MTAM+RXMD-C04 | 17500 [5.1] | 12300 [3.6] | 5200 [1.5] | 13 | 11 | 600 [283.2] | 7507491 |
| | RCF2421HTAM+RXMD-C04 | 17500 [5.1] | 12300 [3.6] | 5200 [1.5] | 13 | 11 | 600 [283.2] | 7507472 |
| RA1324AJ1 | RCF2414STAM+RXMD-C04 | 23800 [7.0] | 17100 [5.0] | 6700 [2.0] | 13 | 11 | 800 [377.6] | 7507612 |
| | RCF2417HTAM+RXMD-C04 | 23400 [6.9] | 16500 [4.8] | 6900 [2.0] | 13 | 11 | 800 [377.6] | 7507630 |
| | RCF2417MTAM+RXMD-C04 | 23400 [6.9] | 16500 [4.8] | 6900 [2.0] | 13 | 11 | 800 [377.6] | 7507648 |
| | RCF2421MTAM+RXMD-C04 | 23400 [6.9] | 16500 [4.8] | 6900 [2.0] | 13 | 11 | 800 [377.6] | 7507716 |
| | RCF2421HTAM+RXMD-C04 | 23400 [6.9] | 16500 [4.8] | 6900 [2.0] | 13 | 11 | 800 [377.6] | 7507691 |
| RA1330AJ1 | RCF3621HTAM+RXMD-C04 | 30000 [8.8] | 22200 [6.5] | 7800 [2.3] | 13.5 | 11.5 | 1000 [471.9] | 8086540 |
| | RCF3621MTAM+RXMD-C04 | 29800 [8.7] | 21900 [6.4] | 7900 [2.3] | 13.5 | 11.5 | 1000 [471.9] | 7507895 |
| | RCF3621STAM+RXMD-C04 | 28400 [8.3] | 20500 [6.0] | 7900 [2.3] | 13 | 11 | 1000 [471.9] | 7507926 |
| | RCF3624HTAM+RXMD-C04 | 30000 [8.8] | 21800 [6.4] | 8200 [2.4] | 13.5 | 11.5 | 1000 [471.9] | 7507950 |
| | RCF3624MTAM+RXMD-C04 | 29800 [8.7] | 21900 [6.4] | 7900 [2.3] | 13.5 | 11.5 | 1000 [471.9] | 7507973 |
| RA1336AC1 | RCF3621HTAM+RXMD-C04 | 36000 [10.6] | 25400 [7.4] | 10600 [3.1] | 13.5 | 11.5 | 1200 [566.3] | 8086568 |
| | RCF3621MTAM+RXMD-C04 | 36000 [10.6] | 24300 [7.1] | 11700 [3.4] | 13.5 | 11.5 | 1025 [483.7] | 7508240 |
| | RCF3621STAM+RXMD-C04 | 34400 [10.1] | 23100 [6.8] | 11300 [3.3] | 13 | 11 | 1025 [483.7] | 7508271 |
| | RCF3624HTAM+RXMD-C04 | 36000 [10.6] | 24200 [7.1] | 11800 [3.5] | 13.5 | 11.5 | 1025 [483.7] | 7508298 |
| | RCF3624MTAM+RXMD-C04 | 36000 [10.6] | 24300 [7.1] | 11700 [3.4] | 13.5 | 11.5 | 1025 [483.7] | 7508325 |
| RA1336AJ1 | RCF3621HTAM+RXMD-C04 | 36000 [10.6] | 25400 [7.4] | 10600 [3.1] | 13.5 | 11.5 | 1200 [566.3] | 8086596 |
| | RCF3621MTAM+RXMD-C04 | 36000 [10.6] | 24300 [7.1] | 11700 [3.4] | 13.5 | 11.5 | 1025 [483.7] | 7508606 |
| | RCF3621STAM+RXMD-C04 | 34400 [10.1] | 23100 [6.8] | 11300 [3.3] | 13 | 11 | 1025 [483.7] | 7508637 |
| | RCF3624HTAM+RXMD-C04 | 36000 [10.6] | 24200 [7.1] | 11800 [3.5] | 13.5 | 11.5 | 1025 [483.7] | 7508664 |
| | RCF3624MTAM+RXMD-C04 | 36000 [10.6] | 24300 [7.1] | 11700 [3.4] | 13.5 | 11.5 | 1025 [483.7] | 7508691 |
| RA1342AC1 | RCF4821MTAM+RXMD-C04 | 41000 [12.0] | 29200 [8.6] | 11800 [3.5] | 13 | 11 | 1400 [660.7] | 8086652 |
| | RCF4824HTAM+RXMD-C04 | 41500 [12.2] | 29400 [8.6] | 12100 [3.5] | 13 | 11.5 | 1400 [660.7] | 7511616 |
| | RCF4824STAM+RXMD-C04 | 40000 [11.7] | 28000 [8.2] | 12000 [3.5] | 13 | 11 | 1375 [648.9] | 7511643 |
| RA1342AJ1 | RCF4821MTAM+RXMD-C04 | 41000 [12.0] | 29200 [8.6] | 11800 [3.5] | 13 | 11 | 1400 [660.7] | 8086708 |
| | RCF4824HTAM+RXMD-C04 | 41500 [12.2] | 29400 [8.6] | 12100 [3.5] | 13 | 11.5 | 1400 [660.7] | 7511850 |
| | RCF4824STAM+RXMD-C04 | 40000 [11.7] | 28000 [8.2] | 12000 [3.5] | 13 | 11 | 1375 [648.9] | 7511877 |
| RA1348AC1 | RCF4821MTAM+RXMD-C04 | 48000 [14.1] | 34400 [10.1] | 13600 [4.0] | 13 | 11 | 1550 [731.5] | 8086744 |
| | RCF4824HTAM+RXMD-C04 | 48000 [14.1] | 32700 [9.6] | 15300 [4.5] | 13 | 11.5 | 1500 [707.9] | 7508968 |
| | RCF4824STAM+RXMD-C04 | 47500 [13.9] | 34100 [10.0] | 13400 [3.9] | 13 | 11 | 1500 [707.9] | 7509019 |
| RA1348AJ1 | RCF4821MTAM+RXMD-C04 | 48000 [14.1] | 34400 [10.1] | 13600 [4.0] | 13 | 11 | 1550 [731.5] | 8086780 |
| | RCF4824HTAM+RXMD-C04 | 48000 [14.1] | 32700 [9.6] | 15300 [4.5] | 13 | 11.5 | 1500 [707.9] | 7509188 |
| | RCF4824STAM+RXMD-C04 | 47500 [13.9] | 34100 [10.0] | 13400 [3.9] | 13 | 11 | 1500 [707.9] | 7509210 |
| RA1360AC1 | RCF6024HTAM+RXMD-C04 | 56000 [16.4] | 39600 [11.6] | 16400 [4.8] | 13 | 11 | 1600 [755.1] | 7509313 |
| RA1360AJ1 | RCF6024HTAM+RXMD-C04 | 56000 [16.4] | 39600 [11.6] | 16400 [4.8] | 13 | 11 | 1600 [755.1] | 7509435 |

[] Designates Metric Conversions

Performance Data @ AHRI Standard Conditions – Cooling (con't.)

| R801T: Classic Plus Single-Stage X-13 80% Furnace Rating | | | | | | | | | |
|--|-----------------|-------------|------------------------------|----------------------------|--------------------------|------|------|---------------------|---------|
| Outdoor Unit | Furnace | Indoor Coil | Total Capacity BTU/H [kW] | Net Sensible BTU/H [kW] | Net Latent BTU/H [kW] | SEER | EER | Indoor CFM [L/s] | AHRI# |
| RA1318AJ1 | R801TA050314MSA | RCF2414STAM | 18000 [5.3] | 13000 [3.8] | 5000 [1.5] | 14.5 | 12 | 625 [295.0] | 7507407 |
| | | RCF2417HTAM | 18000 [5.3] | 12800 [3.8] | 5200 [1.5] | 14.5 | 12 | 625 [295.0] | 7507409 |
| | | RCF2417MTAM | 18000 [5.3] | 12800 [3.8] | 5200 [1.5] | 14.5 | 12 | 625 [295.0] | 7507424 |
| | | RCF2417STAM | 18000 [5.3] | 13500 [4.0] | 4500 [1.3] | 14.5 | 12 | 625 [295.0] | 7507440 |
| RA1318AJ1 | R801TA050314MXA | RCF2414STAM | 18000 [5.3] | 13000 [3.8] | 5000 [1.5] | 14.5 | 12 | 625 [295.0] | 8050154 |
| | | RCF2417HTAM | 18000 [5.3] | 12800 [3.8] | 5200 [1.5] | 14.5 | 12 | 625 [295.0] | 8050155 |
| | | RCF2417MTAM | 18000 [5.3] | 12800 [3.8] | 5200 [1.5] | 14.5 | 12 | 625 [295.0] | 8050162 |
| | | RCF2417STAM | 18000 [5.3] | 13500 [4.0] | 4500 [1.3] | 14.5 | 12 | 625 [295.0] | 8050169 |
| RA1318AJ1 | R801TA075317ZSA | RCF2417HTAM | 18000 [5.3] | 12900 [3.8] | 5100 [1.5] | 14.5 | 12 | 650 [306.8] | 7507410 |
| | | RCF2417MTAM | 18000 [5.3] | 12900 [3.8] | 5100 [1.5] | 14.5 | 12 | 650 [306.8] | 7507425 |
| | | RCF2417STAM | 18000 [5.3] | 13600 [4.0] | 4400 [1.3] | 14.5 | 12 | 650 [306.8] | 7507441 |
| | | RCF2421MTAM | 18000 [5.3] | 12900 [3.8] | 5100 [1.5] | 14.5 | 12 | 650 [306.8] | 7507473 |
| RA1318AJ1 | R801TA075317ZXA | RCF2417HTAM | 18000 [5.3] | 12900 [3.8] | 5100 [1.5] | 14.5 | 12 | 650 [306.8] | 8050156 |
| | | RCF2417MTAM | 18000 [5.3] | 12900 [3.8] | 5100 [1.5] | 14.5 | 12 | 650 [306.8] | 8050163 |
| | | RCF2417STAM | 18000 [5.3] | 13600 [4.0] | 4400 [1.3] | 14.5 | 12 | 650 [306.8] | 8050170 |
| | | RCF2421MTAM | 18000 [5.3] | 12900 [3.8] | 5100 [1.5] | 14.5 | 12 | 650 [306.8] | 8050183 |
| RA1318AJ1 | R801TA075317ZSA | RCF2421HTAM | 18000 [5.3] | 12900 [3.8] | 5100 [1.5] | 14.5 | 12 | 650 [306.8] | 7507454 |
| RA1318AJ1 | R801TA075317ZXA | RCF2421HTAM | 18000 [5.3] | 12900 [3.8] | 5100 [1.5] | 14.5 | 12 | 650 [306.8] | 8050176 |
| RA1324AJ1 | R801TA050314MSA | RCF2414STAM | 24000 [7.0] | 17300 [5.1] | 6700 [2.0] | 14.5 | 12 | 800 [377.6] | 7507611 |
| | | RCF2417HTAM | 24000 [7.0] | 17300 [5.1] | 6700 [2.0] | 14.5 | 12 | 875 [413.0] | 7507613 |
| | | RCF2417MTAM | 24000 [7.0] | 17300 [5.1] | 6700 [2.0] | 14.5 | 12 | 850 [401.2] | 7507631 |
| | | RCF2417STAM | 24000 [7.0] | 18100 [5.3] | 5900 [1.7] | 14 | 11.5 | 825 [389.4] | 7507650 |
| RA1324AJ1 | R801TA050314MXA | RCF2414STAM | 24000 [7.0] | 17300 [5.1] | 6700 [2.0] | 14.5 | 12 | 800 [377.6] | 8050231 |
| | | RCF2417HTAM | 24000 [7.0] | 17300 [5.1] | 6700 [2.0] | 14.5 | 12 | 875 [413.0] | 8050232 |
| | | RCF2417MTAM | 24000 [7.0] | 17300 [5.1] | 6700 [2.0] | 14.5 | 12 | 850 [401.2] | 8050239 |
| | | RCF2417STAM | 24000 [7.0] | 18100 [5.3] | 5900 [1.7] | 14 | 11.5 | 825 [389.4] | 8050246 |
| RA1324AJ1 | R801TA075317ZSA | RCF2417HTAM | 24000 [7.0] | 17300 [5.1] | 6700 [2.0] | 14 | 11.5 | 875 [413.0] | 7507614 |
| | | RCF2417MTAM | 24000 [7.0] | 17300 [5.1] | 6700 [2.0] | 14 | 11.5 | 875 [413.0] | 7507632 |
| | | RCF2417STAM | 24000 [7.0] | 18200 [5.3] | 5800 [1.7] | 14 | 11.5 | 850 [401.2] | 7507651 |
| | | RCF2421MTAM | 24000 [7.0] | 17300 [5.1] | 6700 [2.0] | 14 | 11.5 | 875 [413.0] | 7507692 |
| RA1324AJ1 | R801TA075317ZXA | RCF2417HTAM | 24000 [7.0] | 17300 [5.1] | 6700 [2.0] | 14 | 11.5 | 875 [413.0] | 8050233 |
| | | RCF2417MTAM | 24000 [7.0] | 17300 [5.1] | 6700 [2.0] | 14 | 11.5 | 875 [413.0] | 8050240 |
| | | RCF2417STAM | 24000 [7.0] | 18200 [5.3] | 5800 [1.7] | 14 | 11.5 | 850 [401.2] | 8050247 |
| | | RCF2421MTAM | 24000 [7.0] | 17300 [5.1] | 6700 [2.0] | 14 | 11.5 | 875 [413.0] | 8050263 |
| RA1324AJ1 | R801TA075317ZSA | RCF2421HTAM | 24000 [7.0] | 17300 [5.1] | 6700 [2.0] | 14 | 11.5 | 875 [413.0] | 7507667 |
| RA1324AJ1 | R801TA075317ZXA | RCF2421HTAM | 24000 [7.0] | 17300 [5.1] | 6700 [2.0] | 14 | 11.5 | 875 [413.0] | 8050254 |
| RA1330AJ1 | R801TA050314MSA | RCF3617STAM | 28800 [8.4] | 22000 [6.4] | 6800 [2.0] | 14 | 11.5 | 1000 [471.9] | 7507847 |
| RA1330AJ1 | R801TA050314MXA | RCF3617STAM | 28800 [8.4] | 22000 [6.4] | 6800 [2.0] | 14 | 11.5 | 1000 [471.9] | 8050313 |
| RA1330AJ1 | R801TA075317ZSA | RCF3617STAM | 28400 [8.3] | 21200 [6.2] | 7200 [2.1] | 14 | 11.5 | 875 [413.0] | 7507848 |
| | | RCF3621MTAM | 30000 [8.8] | 22400 [6.6] | 7600 [2.2] | 14.5 | 12 | 1075 [507.3] | 7507865 |
| | | RCF3621STAM | 28400 [8.3] | 21200 [6.2] | 7200 [2.1] | 14 | 11.5 | 875 [413.0] | 7507896 |
| RA1330AJ1 | R801TA075317ZXA | RCF3617STAM | 28400 [8.3] | 21200 [6.2] | 7200 [2.1] | 14 | 11.5 | 875 [413.0] | 8050314 |
| | | RCF3621MTAM | 30000 [8.8] | 22400 [6.6] | 7600 [2.2] | 14.5 | 12 | 1075 [507.3] | 8050320 |
| | | RCF3621STAM | 28400 [8.3] | 21200 [6.2] | 7200 [2.1] | 14 | 11.5 | 875 [413.0] | 8050334 |
| RA1330AJ1 | R801TA075417MSA | RCF3617STAM | 29000 [8.5] | 22200 [6.5] | 6800 [2.0] | 14 | 11.5 | 1000 [471.9] | 7507849 |
| | | RCF3621MTAM | 30000 [8.8] | 22300 [6.5] | 7700 [2.3] | 14.5 | 12 | 1050 [495.5] | 7507866 |
| | | RCF3621STAM | 29200 [8.6] | 22500 [6.6] | 6700 [2.0] | 14 | 11.5 | 1025 [483.7] | 7507897 |

[] Designates Metric Conversions

Performance Data @ AHRI Standard Conditions – Cooling (con't.)

| R801T: Classic Plus Single-Stage X-13 80% Furnace Ratings | | | | | | | | | |
|---|-----------------|-------------|------------------------------|----------------------------|--------------------------|------|------|---------------------|---------|
| Outdoor Unit | Furnace | Indoor Coil | Total Capacity BTU/H [kW] | Net Sensible BTU/H [kW] | Net Latent BTU/H [kW] | SEER | EER | Indoor CFM [L/s] | AHRI# |
| RA1330AJ1 | R801TA075417MXA | RCF3617STAM | 29000 [8.5] | 22200 [6.5] | 6800 [2.0] | 14 | 11.5 | 1000 [471.9] | 8050315 |
| | | RCF3621MTAM | 30000 [8.8] | 22300 [6.5] | 7700 [2.3] | 14.5 | 12 | 1050 [495.5] | 8050321 |
| | | RCF3621STAM | 29200 [8.6] | 22500 [6.6] | 6700 [2.0] | 14 | 11.5 | 1025 [483.7] | 8050335 |
| RA1330AJ1 | R801TA075421MSA | RCF3621HTAM | 30000 [8.8] | 22900 [6.7] | 7100 [2.1] | 15.1 | 12.5 | 1050 [495.5] | 8086516 |
| | | RCF3621MTAM | 30000 [8.8] | 22900 [6.7] | 7100 [2.1] | 14.5 | 12 | 1025 [483.7] | 8049010 |
| | | RCF3621STAM | 29200 [8.6] | 22500 [6.6] | 6700 [2.0] | 14 | 11.5 | 1025 [483.7] | 8049014 |
| | | RCF3624MTAM | 30000 [8.8] | 22900 [6.7] | 7100 [2.1] | 14.5 | 12 | 1025 [483.7] | 8049018 |
| RA1330AJ1 | R801TA075421MXA | RCF3621HTAM | 30000 [8.8] | 22900 [6.7] | 7100 [2.1] | 15.1 | 12.5 | 1050 [495.5] | 8086517 |
| | | RCF3621MTAM | 30000 [8.8] | 22900 [6.7] | 7100 [2.1] | 14.5 | 12 | 1025 [483.7] | 8050322 |
| | | RCF3621STAM | 29200 [8.6] | 22500 [6.6] | 6700 [2.0] | 14 | 11.5 | 1025 [483.7] | 8050336 |
| | | RCF3624MTAM | 30000 [8.8] | 22900 [6.7] | 7100 [2.1] | 14.5 | 12 | 1025 [483.7] | 8050357 |
| RA1330AJ1 | R801TA075521ZSA | RCF3621MTAM | 30000 [8.8] | 22100 [6.5] | 7900 [2.3] | 15 | 12.5 | 1000 [471.9] | 7507867 |
| | | RCF3621STAM | 29000 [8.5] | 22100 [6.5] | 6900 [2.0] | 14 | 11.5 | 975 [460.1] | 7507898 |
| | | RCF3624HTAM | 30000 [8.8] | 21800 [6.4] | 8200 [2.4] | 15.5 | 13 | 1025 [483.7] | 7507927 |
| | | RCF3624MTAM | 30000 [8.8] | 22100 [6.5] | 7900 [2.3] | 15 | 12.5 | 1000 [471.9] | 7507951 |
| RA1330AJ1 | R801TA075521ZXA | RCF3621MTAM | 30000 [8.8] | 22100 [6.5] | 7900 [2.3] | 15 | 12.5 | 1000 [471.9] | 8050323 |
| | | RCF3621STAM | 29000 [8.5] | 22100 [6.5] | 6900 [2.0] | 14 | 11.5 | 975 [460.1] | 8050337 |
| | | RCF3624HTAM | 30000 [8.8] | 21800 [6.4] | 8200 [2.4] | 15.5 | 13 | 1025 [483.7] | 8050348 |
| | | RCF3624MTAM | 30000 [8.8] | 22100 [6.5] | 7900 [2.3] | 15 | 12.5 | 1000 [471.9] | 8050358 |
| RA1330AJ1 | R801TA100521MSA | RCF3621HTAM | 30000 [8.8] | 22900 [6.7] | 7100 [2.1] | 15.5 | 13 | 1075 [507.3] | 8086518 |
| | | RCF3621MTAM | 30000 [8.8] | 22300 [6.5] | 7700 [2.3] | 15.1 | 12.5 | 1050 [495.5] | 7507868 |
| | | RCF3621STAM | 29000 [8.5] | 22200 [6.5] | 6800 [2.0] | 14 | 11.5 | 1000 [471.9] | 7507899 |
| | | RCF3624HTAM | 30000 [8.8] | 22200 [6.5] | 7800 [2.3] | 15.5 | 13 | 1100 [519.1] | 7507928 |
| | | RCF3624MTAM | 30000 [8.8] | 22300 [6.5] | 7700 [2.3] | 15.1 | 12.5 | 1050 [495.5] | 7507952 |
| RA1330AJ1 | R801TA100521MXA | RCF3621MTAM | 30000 [8.8] | 22300 [6.5] | 7700 [2.3] | 15.1 | 12.5 | 1050 [495.5] | 8050324 |
| | | RCF3621STAM | 29000 [8.5] | 22200 [6.5] | 6800 [2.0] | 14 | 11.5 | 1000 [471.9] | 8050338 |
| | | RCF3624HTAM | 30000 [8.8] | 22200 [6.5] | 7800 [2.3] | 15.5 | 13 | 1100 [519.1] | 8050349 |
| | | RCF3624MTAM | 30000 [8.8] | 22300 [6.5] | 7700 [2.3] | 15.1 | 12.5 | 1050 [495.5] | 8050359 |
| RA1330AJ1 | R801TA100521ZSA | RCF3621MTAM | 30000 [8.8] | 22000 [6.4] | 8000 [2.3] | 15.1 | 12.5 | 975 [460.1] | 7507869 |
| | | RCF3621STAM | 29000 [8.5] | 22100 [6.5] | 6900 [2.0] | 14 | 11.5 | 975 [460.1] | 7507900 |
| | | RCF3624HTAM | 30000 [8.8] | 21800 [6.4] | 8200 [2.4] | 15.5 | 13 | 1025 [483.7] | 7507929 |
| | | RCF3624MTAM | 30000 [8.8] | 22000 [6.4] | 8000 [2.3] | 15.1 | 12.5 | 975 [460.1] | 7507953 |
| RA1330AJ1 | R801TA100521ZXA | RCF3621MTAM | 30000 [8.8] | 22000 [6.4] | 8000 [2.3] | 15.1 | 12.5 | 975 [460.1] | 8050325 |
| | | RCF3621STAM | 29000 [8.5] | 22100 [6.5] | 6900 [2.0] | 14 | 11.5 | 975 [460.1] | 8050339 |
| | | RCF3624HTAM | 30000 [8.8] | 21800 [6.4] | 8200 [2.4] | 15.5 | 13 | 1025 [483.7] | 8050350 |
| | | RCF3624MTAM | 30000 [8.8] | 22000 [6.4] | 8000 [2.3] | 15.1 | 12.5 | 975 [460.1] | 8050360 |
| RA1330AJ1 | R801TA125524ZSA | RCF3624HTAM | 30000 [8.8] | 21700 [6.4] | 8300 [2.4] | 15.5 | 13 | 975 [460.1] | 7507930 |
| | | RCF3624MTAM | 30000 [8.8] | 21800 [6.4] | 8200 [2.4] | 15 | 12.5 | 925 [436.6] | 7507954 |
| RA1330AJ1 | R801TA125524ZXA | RCF3624HTAM | 30000 [8.8] | 21700 [6.4] | 8300 [2.4] | 15.5 | 13 | 975 [460.1] | 8050351 |
| | | RCF3624MTAM | 30000 [8.8] | 21800 [6.4] | 8200 [2.4] | 15 | 12.5 | 925 [436.6] | 8050361 |
| RA1336AC1 | R801TA050314MSA | RCF3617STAM | 35000 [10.3] | 24700 [7.2] | 10300 [3.0] | 13.5 | 11.5 | 1000 [471.9] | 7508192 |
| RA1336AC1 | R801TA050314MXA | RCF3617STAM | 35000 [10.3] | 24700 [7.2] | 10300 [3.0] | 13.5 | 11.5 | 1000 [471.9] | 8050439 |
| RA1336AC1 | R801TA075317ZSA | RCF3617STAM | 35000 [10.3] | 25000 [7.3] | 10000 [2.9] | 13.5 | 11.5 | 1050 [495.5] | 7508193 |
| | | RCF3621MTAM | 36000 [10.6] | 25300 [7.4] | 10700 [3.1] | 14 | 11.5 | 1250 [589.9] | 7508210 |
| | | RCF3621STAM | 35000 [10.3] | 25000 [7.3] | 10000 [2.9] | 13.5 | 11.5 | 1050 [495.5] | 7508241 |
| RA1336AC1 | R801TA075317ZXA | RCF3617STAM | 35000 [10.3] | 25000 [7.3] | 10000 [2.9] | 13.5 | 11.5 | 1050 [495.5] | 8050440 |
| | | RCF3621MTAM | 36000 [10.6] | 25300 [7.4] | 10700 [3.1] | 14 | 11.5 | 1250 [589.9] | 8050447 |
| | | RCF3621STAM | 35000 [10.3] | 25000 [7.3] | 10000 [2.9] | 13.5 | 11.5 | 1050 [495.5] | 8050463 |

[] Designates Metric Conversions

Performance Data @ AHRI Standard Conditions – Cooling (con't.)

| R801T: Classic Plus Single-Stage X-13 80% Furnace Ratings | | | | | | | | | |
|---|-----------------|-------------|------------------------------|----------------------------|--------------------------|------|------|---------------------|---------|
| Outdoor Unit | Furnace | Indoor Coil | Total Capacity BTU/H [kW] | Net Sensible BTU/H [kW] | Net Latent BTU/H [kW] | SEER | EER | Indoor CFM [L/s] | AHRI# |
| RA1336AC1 | R801TA075417MSA | RCF3617STAM | 36000 [10.6] | 26800 [7.9] | 9200 [2.7] | 13.5 | 11.5 | 1225 [578.1] | 7508194 |
| | | RCF3621HTAM | 36000 [10.6] | 25400 [7.4] | 10600 [3.1] | 15 | 12.5 | 1050 [495.5] | 8086543 |
| | | RCF3621MTAM | 36000 [10.6] | 25100 [7.4] | 10900 [3.2] | 14.5 | 12 | 1200 [566.3] | 7508211 |
| | | RCF3621STAM | 36000 [10.6] | 26900 [7.9] | 9100 [2.7] | 13.5 | 11.5 | 1250 [589.9] | 7508242 |
| RA1336AC1 | R801TA075417MXA | RCF3617STAM | 36000 [10.6] | 26800 [7.9] | 9200 [2.7] | 13.5 | 11.5 | 1225 [578.1] | 8050441 |
| | | RCF3621MTAM | 36000 [10.6] | 25100 [7.4] | 10900 [3.2] | 14.5 | 12 | 1200 [566.3] | 8050448 |
| | | RCF3621STAM | 36000 [10.6] | 26900 [7.9] | 9100 [2.7] | 13.5 | 11.5 | 1250 [589.9] | 8050464 |
| RA1336AC1 | R801TA075421MSA | RCF3621HTAM | 36000 [10.6] | 25400 [7.4] | 10600 [3.1] | 15 | 12.5 | 1050 [495.5] | 8086544 |
| | | RCF3621MTAM | 36000 [10.6] | 25400 [7.4] | 10600 [3.1] | 14.5 | 12 | 1225 [578.1] | 8049042 |
| | | RCF3621STAM | 35000 [10.3] | 24700 [7.2] | 10300 [3.0] | 14 | 11.5 | 1000 [471.9] | 8049046 |
| | | RCF3624HTAM | 36000 [10.6] | 25400 [7.4] | 10600 [3.1] | 15.1 | 12.5 | 1225 [578.1] | 8049050 |
| | | RCF3624MTAM | 36000 [10.6] | 25400 [7.4] | 10600 [3.1] | 14.5 | 12 | 1225 [578.1] | 8049052 |
| RA1336AC1 | R801TA075421MXA | RCF3621HTAM | 36000 [10.6] | 25400 [7.4] | 10600 [3.1] | 15 | 12.5 | 1050 [495.5] | 8086545 |
| | | RCF3621MTAM | 36000 [10.6] | 25400 [7.4] | 10600 [3.1] | 14.5 | 12 | 1225 [578.1] | 8050449 |
| | | RCF3621STAM | 35000 [10.3] | 24700 [7.2] | 10300 [3.0] | 14 | 11.5 | 1000 [471.9] | 8050465 |
| | | RCF3624HTAM | 36000 [10.6] | 25400 [7.4] | 10600 [3.1] | 15.1 | 12.5 | 1225 [578.1] | 8050479 |
| | | RCF3624MTAM | 36000 [10.6] | 25400 [7.4] | 10600 [3.1] | 14.5 | 12 | 1225 [578.1] | 8050492 |
| RA1336AC1 | R801TA075521ZSA | RCF3621MTAM | 36000 [10.6] | 24100 [7.1] | 11900 [3.5] | 14.5 | 12 | 1000 [471.9] | 7508212 |
| | | RCF3621STAM | 35800 [10.5] | 26300 [7.7] | 9500 [2.8] | 13.5 | 11.5 | 1175 [554.5] | 7508243 |
| | | RCF3624HTAM | 36000 [10.6] | 24200 [7.1] | 11800 [3.5] | 15.1 | 12.5 | 1025 [483.7] | 7508272 |
| | | RCF3624MTAM | 36000 [10.6] | 24100 [7.1] | 11900 [3.5] | 14.5 | 12 | 1000 [471.9] | 7508299 |
| RA1336AC1 | R801TA075521ZXA | RCF3621MTAM | 36000 [10.6] | 24100 [7.1] | 11900 [3.5] | 14.5 | 12 | 1000 [471.9] | 8050450 |
| | | RCF3621STAM | 35800 [10.5] | 26300 [7.7] | 9500 [2.8] | 13.5 | 11.5 | 1175 [554.5] | 8050466 |
| | | RCF3624HTAM | 36000 [10.6] | 24200 [7.1] | 11800 [3.5] | 15.1 | 12.5 | 1025 [483.7] | 8050480 |
| | | RCF3624MTAM | 36000 [10.6] | 24100 [7.1] | 11900 [3.5] | 14.5 | 12 | 1000 [471.9] | 8050493 |
| RA1336AC1 | R801TA100521MSA | RCF3621HTAM | 36000 [10.6] | 25400 [7.4] | 10600 [3.1] | 15.1 | 12.5 | 1075 [507.3] | 8086546 |
| | | RCF3621MTAM | 36000 [10.6] | 24300 [7.1] | 11700 [3.4] | 14.5 | 12 | 1050 [495.5] | 7508213 |
| | | RCF3621STAM | 35200 [10.3] | 24900 [7.3] | 10300 [3.0] | 14 | 11.5 | 1000 [471.9] | 7508244 |
| | | RCF3624HTAM | 36000 [10.6] | 24500 [7.2] | 11500 [3.4] | 15.1 | 12.5 | 1100 [519.1] | 7508273 |
| | | RCF3624MTAM | 36000 [10.6] | 24300 [7.1] | 11700 [3.4] | 14.5 | 12 | 1050 [495.5] | 7508300 |
| RA1336AC1 | R801TA100521MXA | RCF3621MTAM | 36000 [10.6] | 24300 [7.1] | 11700 [3.4] | 14.5 | 12 | 1050 [495.5] | 8050451 |
| | | RCF3621STAM | 35200 [10.3] | 24900 [7.3] | 10300 [3.0] | 14 | 11.5 | 1000 [471.9] | 8050467 |
| | | RCF3624HTAM | 36000 [10.6] | 24500 [7.2] | 11500 [3.4] | 15.1 | 12.5 | 1100 [519.1] | 8050481 |
| | | RCF3624MTAM | 36000 [10.6] | 24300 [7.1] | 11700 [3.4] | 14.5 | 12 | 1050 [495.5] | 8050494 |
| RA1336AC1 | R801TA100521ZSA | RCF3621MTAM | 36000 [10.6] | 25200 [7.4] | 10800 [3.2] | 14.5 | 12 | 1225 [578.1] | 7508214 |
| | | RCF3621STAM | 35800 [10.5] | 26300 [7.7] | 9500 [2.8] | 13.5 | 11.5 | 1175 [554.5] | 7508245 |
| | | RCF3624HTAM | 36000 [10.6] | 24200 [7.1] | 11800 [3.5] | 15.1 | 12.5 | 1025 [483.7] | 7508274 |
| | | RCF3624MTAM | 36000 [10.6] | 25200 [7.4] | 10800 [3.2] | 14.5 | 12 | 1225 [578.1] | 7508301 |
| RA1336AC1 | R801TA100521ZXA | RCF3621MTAM | 36000 [10.6] | 25200 [7.4] | 10800 [3.2] | 14.5 | 12 | 1225 [578.1] | 8050452 |
| | | RCF3621STAM | 35800 [10.5] | 26300 [7.7] | 9500 [2.8] | 13.5 | 11.5 | 1175 [554.5] | 8050468 |
| | | RCF3624HTAM | 36000 [10.6] | 24200 [7.1] | 11800 [3.5] | 15.1 | 12.5 | 1025 [483.7] | 8050482 |
| | | RCF3624MTAM | 36000 [10.6] | 25200 [7.4] | 10800 [3.2] | 14.5 | 12 | 1225 [578.1] | 8050495 |
| RA1336AC1 | R801TA125524MSA | RCF3624HTAM | 36000 [10.6] | 25000 [7.3] | 11000 [3.2] | 15.1 | 12.5 | 1200 [566.3] | 7508275 |
| | | RCF3624MTAM | 36000 [10.6] | 24900 [7.3] | 11100 [3.3] | 14.5 | 12 | 1175 [554.5] | 7508302 |
| RA1336AC1 | R801TA125524MXA | RCF3624HTAM | 36000 [10.6] | 25000 [7.3] | 11000 [3.2] | 15.1 | 12.5 | 1200 [566.3] | 8050483 |
| | | RCF3624MTAM | 36000 [10.6] | 24900 [7.3] | 11100 [3.3] | 14.5 | 12 | 1175 [554.5] | 8050496 |
| RA1336AC1 | R801TA125524ZSA | RCF3624HTAM | 36000 [10.6] | 24800 [7.3] | 11200 [3.3] | 15.1 | 12.5 | 1150 [542.7] | 7508276 |
| | | RCF3624MTAM | 36000 [10.6] | 24600 [7.2] | 11400 [3.3] | 14.5 | 12 | 1100 [519.1] | 7508303 |

[] Designates Metric Conversions



Performance Data @ AHRI Standard Conditions – Cooling (con't.)

| R801T: Classic Plus Single-Stage X-13 80% Furnace Ratings | | | | | | | | | |
|---|-----------------|-------------|---------------------------|-------------------------|-----------------------|------|------|------------------|---------|
| Outdoor Unit | Furnace | Indoor Coil | Total Capacity BTU/H [kW] | Net Sensible BTU/H [kW] | Net Latent BTU/H [kW] | SEER | EER | Indoor CFM [L/s] | AHRI# |
| RA1336AC1 | R801TA125524ZXA | RCF3624HTAM | 36000 [10.6] | 24800 [7.3] | 11200 [3.3] | 15.1 | 12.5 | 1150 [542.7] | 8050484 |
| | | RCF3624MTAM | 36000 [10.6] | 24600 [7.2] | 11400 [3.3] | 14.5 | 12 | 1100 [519.1] | 8050497 |
| RA1336AJ1 | R801TA050314MSA | RCF3617STAM | 35000 [10.3] | 24700 [7.2] | 10300 [3.0] | 13.5 | 11.5 | 1000 [471.9] | 7508558 |
| RA1336AJ1 | R801TA050314MXA | RCF3617STAM | 35000 [10.3] | 24700 [7.2] | 10300 [3.0] | 13.5 | 11.5 | 1000 [471.9] | 8050584 |
| RA1336AJ1 | R801TA075317ZSA | RCF3617STAM | 35000 [10.3] | 25000 [7.3] | 10000 [2.9] | 13.5 | 11.5 | 1050 [495.5] | 7508559 |
| | | RCF3621MTAM | 36000 [10.6] | 25300 [7.4] | 10700 [3.1] | 14 | 11.5 | 1250 [589.9] | 7508576 |
| | | RCF3621STAM | 35000 [10.3] | 25000 [7.3] | 10000 [2.9] | 13.5 | 11.5 | 1050 [495.5] | 7508607 |
| RA1336AJ1 | R801TA075317ZXA | RCF3617STAM | 35000 [10.3] | 25000 [7.3] | 10000 [2.9] | 13.5 | 11.5 | 1050 [495.5] | 8050585 |
| | | RCF3621MTAM | 36000 [10.6] | 25300 [7.4] | 10700 [3.1] | 14 | 11.5 | 1250 [589.9] | 8050592 |
| | | RCF3621STAM | 35000 [10.3] | 25000 [7.3] | 10000 [2.9] | 13.5 | 11.5 | 1050 [495.5] | 8050608 |
| RA1336AJ1 | R801TA075417MSA | RCF3617STAM | 36000 [10.6] | 26800 [7.9] | 9200 [2.7] | 13.5 | 11.5 | 1225 [578.1] | 7508560 |
| | | RCF3621HTAM | 36000 [10.6] | 25400 [7.4] | 10600 [3.1] | 15 | 12.5 | 1050 [495.5] | 8086571 |
| | | RCF3621MTAM | 36000 [10.6] | 25100 [7.4] | 10900 [3.2] | 14.5 | 12 | 1200 [566.3] | 7508577 |
| | | RCF3621STAM | 36000 [10.6] | 26900 [7.9] | 9100 [2.7] | 13.5 | 11.5 | 1250 [589.9] | 7508608 |
| RA1336AJ1 | R801TA075417MXA | RCF3617STAM | 36000 [10.6] | 26800 [7.9] | 9200 [2.7] | 13.5 | 11.5 | 1225 [578.1] | 8050586 |
| | | RCF3621MTAM | 36000 [10.6] | 25100 [7.4] | 10900 [3.2] | 14.5 | 12 | 1200 [566.3] | 8050593 |
| | | RCF3621STAM | 36000 [10.6] | 26900 [7.9] | 9100 [2.7] | 13.5 | 11.5 | 1250 [589.9] | 8050609 |
| RA1336AJ1 | R801TA075421MSA | RCF3621HTAM | 36000 [10.6] | 25400 [7.4] | 10600 [3.1] | 15 | 12.5 | 1050 [495.5] | 8086572 |
| | | RCF3621MTAM | 36000 [10.6] | 25400 [7.4] | 10600 [3.1] | 14.5 | 12 | 1225 [578.1] | 8049076 |
| | | RCF3621STAM | 35000 [10.3] | 24700 [7.2] | 10300 [3.0] | 14 | 11.5 | 1000 [471.9] | 8049080 |
| | | RCF3624HTAM | 36000 [10.6] | 25400 [7.4] | 10600 [3.1] | 15.1 | 12.5 | 1225 [578.1] | 8049084 |
| RA1336AJ1 | R801TA075421MXA | RCF3624MTAM | 36000 [10.6] | 25400 [7.4] | 10600 [3.1] | 14.5 | 12 | 1225 [578.1] | 8049086 |
| | | RCF3621HTAM | 36000 [10.6] | 25400 [7.4] | 10600 [3.1] | 15 | 12.5 | 1050 [495.5] | 8086573 |
| | | RCF3621MTAM | 36000 [10.6] | 25400 [7.4] | 10600 [3.1] | 14.5 | 12 | 1225 [578.1] | 8050594 |
| | | RCF3621STAM | 35000 [10.3] | 24700 [7.2] | 10300 [3.0] | 14 | 11.5 | 1000 [471.9] | 8050610 |
| RA1336AJ1 | R801TA075521ZSA | RCF3624HTAM | 36000 [10.6] | 25400 [7.4] | 10600 [3.1] | 15.1 | 12.5 | 1225 [578.1] | 8050625 |
| | | RCF3624MTAM | 36000 [10.6] | 25400 [7.4] | 10600 [3.1] | 14.5 | 12 | 1225 [578.1] | 8050654 |
| | | RCF3621MTAM | 36000 [10.6] | 24100 [7.1] | 11900 [3.5] | 14.5 | 12 | 1000 [471.9] | 7508578 |
| | | RCF3621STAM | 35800 [10.5] | 26300 [7.7] | 9500 [2.8] | 13.5 | 11.5 | 1175 [554.5] | 7508609 |
| RA1336AJ1 | R801TA075521ZXA | RCF3624HTAM | 36000 [10.6] | 24200 [7.1] | 11800 [3.5] | 15.1 | 12.5 | 1025 [483.7] | 7508638 |
| | | RCF3624MTAM | 36000 [10.6] | 24100 [7.1] | 11900 [3.5] | 14.5 | 12 | 1000 [471.9] | 7508665 |
| | | RCF3621MTAM | 36000 [10.6] | 24100 [7.1] | 11900 [3.5] | 14.5 | 12 | 1000 [471.9] | 8050595 |
| | | RCF3621STAM | 35800 [10.5] | 26300 [7.7] | 9500 [2.8] | 13.5 | 11.5 | 1175 [554.5] | 8050611 |
| RA1336AJ1 | R801TA100521MSA | RCF3624HTAM | 36000 [10.6] | 24200 [7.1] | 11800 [3.5] | 15.1 | 12.5 | 1025 [483.7] | 8050626 |
| | | RCF3624MTAM | 36000 [10.6] | 24100 [7.1] | 11900 [3.5] | 14.5 | 12 | 1000 [471.9] | 8050656 |
| | | RCF3621HTAM | 36000 [10.6] | 25400 [7.4] | 10600 [3.1] | 15.1 | 12.5 | 1075 [507.3] | 8086574 |
| | | RCF3621MTAM | 36000 [10.6] | 24300 [7.1] | 11700 [3.4] | 14.5 | 12 | 1050 [495.5] | 7508579 |
| RA1336AJ1 | R801TA100521MXA | RCF3621STAM | 35200 [10.3] | 24900 [7.3] | 10300 [3.0] | 14 | 11.5 | 1000 [471.9] | 7508610 |
| | | RCF3624HTAM | 36000 [10.6] | 24500 [7.2] | 11500 [3.4] | 15.1 | 12.5 | 1100 [519.1] | 7508639 |
| | | RCF3624MTAM | 36000 [10.6] | 24300 [7.1] | 11700 [3.4] | 14.5 | 12 | 1050 [495.5] | 7508666 |
| | | RCF3621MTAM | 36000 [10.6] | 24300 [7.1] | 11700 [3.4] | 14.5 | 12 | 1050 [495.5] | 8050596 |
| RA1336AJ1 | R801TA100521ZSA | RCF3621STAM | 35200 [10.3] | 24900 [7.3] | 10300 [3.0] | 14 | 11.5 | 1000 [471.9] | 8050612 |
| | | RCF3624HTAM | 36000 [10.6] | 24500 [7.2] | 11500 [3.4] | 15.1 | 12.5 | 1100 [519.1] | 8050627 |
| | | RCF3624MTAM | 36000 [10.6] | 24300 [7.1] | 11700 [3.4] | 14.5 | 12 | 1050 [495.5] | 8050659 |
| | | RCF3621MTAM | 36000 [10.6] | 25200 [7.4] | 10800 [3.2] | 14.5 | 12 | 1225 [578.1] | 7508580 |
| RA1336AJ1 | R801TA100521ZSA | RCF3621STAM | 35800 [10.5] | 26300 [7.7] | 9500 [2.8] | 13.5 | 11.5 | 1175 [554.5] | 7508611 |
| | | RCF3624HTAM | 36000 [10.6] | 24200 [7.1] | 11800 [3.5] | 15.1 | 12.5 | 1025 [483.7] | 7508640 |
| | | RCF3624MTAM | 36000 [10.6] | 25200 [7.4] | 10800 [3.2] | 14.5 | 12 | 1225 [578.1] | 7508667 |

[] Designates Metric Conversions

Performance Data @ AHRI Standard Conditions – Cooling (con't.)

| R801T: Classic Plus Single-Stage X-13 80% Furnace Ratings | | | | | | | | | |
|---|-----------------|-------------|------------------------------|----------------------------|--------------------------|------|------|---------------------|---------|
| Outdoor Unit | Furnace | Indoor Coil | Total Capacity BTU/H [kW] | Net Sensible BTU/H [kW] | Net Latent BTU/H [kW] | SEER | EER | Indoor CFM [L/s] | AHRI# |
| RA1336AJ1 | R801TA100521ZXA | RCF3621MTAM | 36000 [10.6] | 25200 [7.4] | 10800 [3.2] | 14.5 | 12 | 1225 [578.1] | 8050597 |
| | | RCF3621STAM | 35800 [10.5] | 26300 [7.7] | 9500 [2.8] | 13.5 | 11.5 | 1175 [554.5] | 8050614 |
| | | RCF3624HTAM | 36000 [10.6] | 24200 [7.1] | 11800 [3.5] | 15.1 | 12.5 | 1025 [483.7] | 8050628 |
| | | RCF3624MTAM | 36000 [10.6] | 25200 [7.4] | 10800 [3.2] | 14.5 | 12 | 1225 [578.1] | 8050661 |
| RA1336AJ1 | R801TA125524MSA | RCF3624HTAM | 36000 [10.6] | 25000 [7.3] | 11000 [3.2] | 15.1 | 12.5 | 1200 [566.3] | 7508641 |
| | | RCF3624MTAM | 36000 [10.6] | 24900 [7.3] | 11100 [3.3] | 14.5 | 12 | 1175 [554.5] | 7508668 |
| RA1336AJ1 | R801TA125524MXA | RCF3624HTAM | 36000 [10.6] | 25000 [7.3] | 11000 [3.2] | 15.1 | 12.5 | 1200 [566.3] | 8050629 |
| | | RCF3624MTAM | 36000 [10.6] | 24900 [7.3] | 11100 [3.3] | 14.5 | 12 | 1175 [554.5] | 8050663 |
| RA1336AJ1 | R801TA125524ZSA | RCF3624HTAM | 36000 [10.6] | 24800 [7.3] | 11200 [3.3] | 15.1 | 12.5 | 1150 [542.7] | 7508642 |
| | | RCF3624MTAM | 36000 [10.6] | 24600 [7.2] | 11400 [3.3] | 14.5 | 12 | 1100 [519.1] | 7508669 |
| RA1336AJ1 | R801TA125524ZXA | RCF3624HTAM | 36000 [10.6] | 24800 [7.3] | 11200 [3.3] | 15.1 | 12.5 | 1150 [542.7] | 8050631 |
| | | RCF3624MTAM | 36000 [10.6] | 24600 [7.2] | 11400 [3.3] | 14.5 | 12 | 1100 [519.1] | 8050666 |
| RA1342AC1 | R801TA075317ZSA | RCF4821MTAM | 40500 [11.9] | 27900 [8.2] | 12600 [3.7] | 13.5 | 11.5 | 1250 [589.9] | 8086599 |
| | | RCF4821STAM | 40000 [11.7] | 29000 [8.5] | 11000 [3.2] | 13.5 | 11.5 | 1250 [589.9] | 7511559 |
| RA1342AC1 | R801TA075317ZXA | RCF4821STAM | 40000 [11.7] | 29000 [8.5] | 11000 [3.2] | 13.5 | 11.5 | 1250 [589.9] | 8050895 |
| RA1342AC1 | R801TA075417MSA | RCF4821MTAM | 41000 [12.0] | 28700 [8.4] | 12300 [3.6] | 14 | 11.5 | 1300 [613.5] | 8086600 |
| | | RCF4821STAM | 40000 [11.7] | 29100 [8.5] | 10900 [3.2] | 13.5 | 11.5 | 1275 [601.7] | 7511560 |
| RA1342AC1 | R801TA075417MXA | RCF4821STAM | 40000 [11.7] | 29100 [8.5] | 10900 [3.2] | 13.5 | 11.5 | 1275 [601.7] | 8050898 |
| RA1342AC1 | R801TA075421MSA | RCF4821MTAM | 41000 [12.0] | 28400 [8.3] | 12600 [3.7] | 14 | 11.5 | 1250 [589.9] | 8086601 |
| | | RCF4821STAM | 40500 [11.9] | 30300 [8.9] | 10200 [3.0] | 13.5 | 11.5 | 1400 [660.7] | 8049108 |
| | | RCF4824HTAM | 42000 [12.3] | 31400 [9.2] | 10600 [3.1] | 14 | 11.5 | 1450 [684.3] | 8049114 |
| | | RCF4824STAM | 40500 [11.9] | 30300 [8.9] | 10200 [3.0] | 13.5 | 11.5 | 1400 [660.7] | 8049119 |
| RA1342AC1 | R801TA075421MXA | RCF4821STAM | 40500 [11.9] | 30300 [8.9] | 10200 [3.0] | 13.5 | 11.5 | 1400 [660.7] | 8050901 |
| | | RCF4824HTAM | 42000 [12.3] | 31400 [9.2] | 10600 [3.1] | 14 | 11.5 | 1450 [684.3] | 8050934 |
| | | RCF4824STAM | 40500 [11.9] | 30300 [8.9] | 10200 [3.0] | 13.5 | 11.5 | 1400 [660.7] | 8050967 |
| RA1342AC1 | R801TA075521ZSA | RCF4821MTAM | 41000 [12.0] | 28400 [8.3] | 12600 [3.7] | 14 | 11.5 | 1250 [589.9] | 8086602 |
| | | RCF4821STAM | 40000 [11.7] | 28800 [8.4] | 11200 [3.3] | 13.5 | 11.5 | 1225 [578.1] | 7511561 |
| | | RCF4824HTAM | 41500 [12.2] | 28600 [8.4] | 12900 [3.8] | 14 | 11.5 | 1250 [589.9] | 7511589 |
| | | RCF4824STAM | 40000 [11.7] | 28800 [8.4] | 11200 [3.3] | 13.5 | 11.5 | 1225 [578.1] | 7511617 |
| RA1342AC1 | R801TA075521ZXA | RCF4821STAM | 40000 [11.7] | 28800 [8.4] | 11200 [3.3] | 13.5 | 11.5 | 1225 [578.1] | 8050904 |
| | | RCF4824HTAM | 41500 [12.2] | 28600 [8.4] | 12900 [3.8] | 14 | 11.5 | 1250 [589.9] | 8050936 |
| | | RCF4824STAM | 40000 [11.7] | 28800 [8.4] | 11200 [3.3] | 13.5 | 11.5 | 1225 [578.1] | 8050969 |
| RA1342AC1 | R801TA100521MSA | RCF4821MTAM | 41500 [12.2] | 29700 [8.7] | 11800 [3.5] | 14 | 11.5 | 1425 [672.5] | 8086603 |
| | | RCF4821STAM | 40500 [11.9] | 29900 [8.8] | 10600 [3.1] | 14 | 11.5 | 1325 [625.3] | 7511562 |
| | | RCF4824HTAM | 42000 [12.3] | 29600 [8.7] | 12400 [3.6] | 14.5 | 12 | 1350 [637.1] | 7511590 |
| | | RCF4824STAM | 40500 [11.9] | 29900 [8.8] | 10600 [3.1] | 14 | 11.5 | 1325 [625.3] | 7511618 |
| RA1342AC1 | R801TA100521MXA | RCF4821STAM | 40500 [11.9] | 29900 [8.8] | 10600 [3.1] | 14 | 11.5 | 1325 [625.3] | 8050906 |
| | | RCF4824HTAM | 42000 [12.3] | 29600 [8.7] | 12400 [3.6] | 14.5 | 12 | 1350 [637.1] | 8050938 |
| | | RCF4824STAM | 40500 [11.9] | 29900 [8.8] | 10600 [3.1] | 14 | 11.5 | 1325 [625.3] | 8050972 |
| RA1342AC1 | R801TA100521ZSA | RCF4821MTAM | 41000 [12.0] | 28400 [8.3] | 12600 [3.7] | 14 | 11.5 | 1250 [589.9] | 8086604 |
| | | RCF4821STAM | 40500 [11.9] | 30300 [8.9] | 10200 [3.0] | 13.5 | 11.5 | 1425 [672.5] | 7511563 |
| | | RCF4824HTAM | 42000 [12.3] | 30200 [8.9] | 11800 [3.5] | 14 | 11.5 | 1450 [684.3] | 7511591 |
| | | RCF4824STAM | 40500 [11.9] | 30300 [8.9] | 10200 [3.0] | 13.5 | 11.5 | 1425 [672.5] | 7511619 |
| RA1342AC1 | R801TA100521ZXA | RCF4821STAM | 40500 [11.9] | 30300 [8.9] | 10200 [3.0] | 13.5 | 11.5 | 1425 [672.5] | 8050908 |
| | | RCF4824HTAM | 42000 [12.3] | 30200 [8.9] | 11800 [3.5] | 14 | 11.5 | 1450 [684.3] | 8050941 |
| | | RCF4824STAM | 40500 [11.9] | 30300 [8.9] | 10200 [3.0] | 13.5 | 11.5 | 1425 [672.5] | 8050974 |
| RA1342AC1 | R801TA125524MSA | RCF4824HTAM | 42000 [12.3] | 29900 [8.8] | 12100 [3.5] | 14.5 | 12 | 1400 [660.7] | 7511592 |
| | | RCF4824STAM | 40500 [11.9] | 30000 [8.8] | 10500 [3.1] | 14 | 11.5 | 1350 [637.1] | 7511620 |

[] Designates Metric Conversions

Performance Data @ AHRI Standard Conditions – Cooling (con't.)

| R801T: Classic Plus Single-Stage X-13 80% Furnace Ratings | | | | | | | | | |
|---|-----------------|-------------|---------------------------|-------------------------|-----------------------|------|------|------------------|---------|
| Outdoor Unit | Furnace | Indoor Coil | Total Capacity BTU/H [kW] | Net Sensible BTU/H [kW] | Net Latent BTU/H [kW] | SEER | EER | Indoor CFM [L/s] | AHRI# |
| RA1342AC1 | R801TA125524MXA | RCF4824HTAM | 42000 [12.3] | 29900 [8.8] | 12100 [3.5] | 14.5 | 12 | 1400 [660.7] | 8050943 |
| | | RCF4824STAM | 40500 [11.9] | 30000 [8.8] | 10500 [3.1] | 14 | 11.5 | 1350 [637.1] | 8050977 |
| RA1342AC1 | R801TA125524ZSA | RCF4824HTAM | 41500 [12.2] | 28100 [8.2] | 13400 [3.9] | 14.5 | 12 | 1150 [542.7] | 7511593 |
| | | RCF4824STAM | 39500 [11.6] | 27700 [8.1] | 11800 [3.5] | 14 | 11.5 | 1100 [519.1] | 7511621 |
| RA1342AC1 | R801TA125524ZXA | RCF4824HTAM | 41500 [12.2] | 28100 [8.2] | 13400 [3.9] | 14.5 | 12 | 1150 [542.7] | 8050946 |
| | | RCF4824STAM | 39500 [11.6] | 27700 [8.1] | 11800 [3.5] | 14 | 11.5 | 1100 [519.1] | 8050979 |
| RA1342AJ1 | R801TA075317ZSA | RCF4821MTAM | 40500 [11.9] | 27900 [8.2] | 12600 [3.7] | 13.5 | 11.5 | 1250 [589.9] | 8086655 |
| | | RCF4821STAM | 40000 [11.7] | 29000 [8.5] | 11000 [3.2] | 13.5 | 11.5 | 1250 [589.9] | 7511793 |
| RA1342AJ1 | R801TA075317ZXA | RCF4821STAM | 40000 [11.7] | 29000 [8.5] | 11000 [3.2] | 13.5 | 11.5 | 1250 [589.9] | 8051115 |
| RA1342AJ1 | R801TA075417MSA | RCF4821MTAM | 41000 [12.0] | 28700 [8.4] | 12300 [3.6] | 14 | 11.5 | 1300 [613.5] | 8086656 |
| | | RCF4821STAM | 40000 [11.7] | 29100 [8.5] | 10900 [3.2] | 13.5 | 11.5 | 1275 [601.7] | 7511794 |
| RA1342AJ1 | R801TA075417MXA | RCF4821STAM | 40000 [11.7] | 29100 [8.5] | 10900 [3.2] | 13.5 | 11.5 | 1275 [601.7] | 8051117 |
| RA1342AJ1 | R801TA075421MSA | RCF4821MTAM | 41000 [12.0] | 28400 [8.3] | 12600 [3.7] | 14 | 11.5 | 1250 [589.9] | 8086657 |
| | | RCF4821STAM | 40500 [11.9] | 30300 [8.9] | 10200 [3.0] | 13.5 | 11.5 | 1400 [660.7] | 8049140 |
| | | RCF4824HTAM | 42000 [12.3] | 31400 [9.2] | 10600 [3.1] | 14 | 11.5 | 1450 [684.3] | 8049146 |
| | | RCF4824STAM | 40500 [11.9] | 30300 [8.9] | 10200 [3.0] | 13.5 | 11.5 | 1400 [660.7] | 8049151 |
| RA1342AJ1 | R801TA075421MXA | RCF4821STAM | 40500 [11.9] | 30300 [8.9] | 10200 [3.0] | 13.5 | 11.5 | 1400 [660.7] | 8051120 |
| | | RCF4824HTAM | 42000 [12.3] | 31400 [9.2] | 10600 [3.1] | 14 | 11.5 | 1450 [684.3] | 8051151 |
| | | RCF4824STAM | 40500 [11.9] | 30300 [8.9] | 10200 [3.0] | 13.5 | 11.5 | 1400 [660.7] | 8051185 |
| RA1342AJ1 | R801TA075521ZSA | RCF4821MTAM | 41000 [12.0] | 28400 [8.3] | 12600 [3.7] | 14 | 11.5 | 1250 [589.9] | 8086658 |
| | | RCF4821STAM | 40000 [11.7] | 28800 [8.4] | 11200 [3.3] | 13.5 | 11.5 | 1225 [578.1] | 7511795 |
| | | RCF4824HTAM | 41500 [12.2] | 28600 [8.4] | 12900 [3.8] | 14 | 11.5 | 1250 [589.9] | 7511823 |
| | | RCF4824STAM | 40000 [11.7] | 28800 [8.4] | 11200 [3.3] | 13.5 | 11.5 | 1225 [578.1] | 7511851 |
| RA1342AJ1 | R801TA075521ZXA | RCF4821STAM | 40000 [11.7] | 28800 [8.4] | 11200 [3.3] | 13.5 | 11.5 | 1225 [578.1] | 8051122 |
| | | RCF4824HTAM | 41500 [12.2] | 28600 [8.4] | 12900 [3.8] | 14 | 11.5 | 1250 [589.9] | 8051154 |
| | | RCF4824STAM | 40000 [11.7] | 28800 [8.4] | 11200 [3.3] | 13.5 | 11.5 | 1225 [578.1] | 8051187 |
| RA1342AJ1 | R801TA100521MSA | RCF4821MTAM | 41500 [12.2] | 29700 [8.7] | 11800 [3.5] | 14 | 11.5 | 1425 [672.5] | 8086659 |
| | | RCF4821STAM | 40500 [11.9] | 29900 [8.8] | 10600 [3.1] | 14 | 11.5 | 1325 [625.3] | 7511796 |
| | | RCF4824HTAM | 42000 [12.3] | 29600 [8.7] | 12400 [3.6] | 14.5 | 12 | 1350 [637.1] | 7511824 |
| | | RCF4824STAM | 40500 [11.9] | 29900 [8.8] | 10600 [3.1] | 14 | 11.5 | 1325 [625.3] | 7511852 |
| RA1342AJ1 | R801TA100521MXA | RCF4821STAM | 40500 [11.9] | 29900 [8.8] | 10600 [3.1] | 14 | 11.5 | 1325 [625.3] | 8051124 |
| | | RCF4824HTAM | 42000 [12.3] | 29600 [8.7] | 12400 [3.6] | 14.5 | 12 | 1350 [637.1] | 8051156 |
| | | RCF4824STAM | 40500 [11.9] | 29900 [8.8] | 10600 [3.1] | 14 | 11.5 | 1325 [625.3] | 8051189 |
| RA1342AJ1 | R801TA100521ZSA | RCF4821MTAM | 41000 [12.0] | 28400 [8.3] | 12600 [3.7] | 14 | 11.5 | 1250 [589.9] | 8086660 |
| | | RCF4821STAM | 40500 [11.9] | 30300 [8.9] | 10200 [3.0] | 13.5 | 11.5 | 1425 [672.5] | 7511797 |
| | | RCF4824HTAM | 42000 [12.3] | 30200 [8.9] | 11800 [3.5] | 14 | 11.5 | 1450 [684.3] | 7511825 |
| | | RCF4824STAM | 40500 [11.9] | 30300 [8.9] | 10200 [3.0] | 13.5 | 11.5 | 1425 [672.5] | 7511853 |
| RA1342AJ1 | R801TA100521ZXA | RCF4821STAM | 40500 [11.9] | 30300 [8.9] | 10200 [3.0] | 13.5 | 11.5 | 1425 [672.5] | 8051127 |
| | | RCF4824HTAM | 42000 [12.3] | 30200 [8.9] | 11800 [3.5] | 14 | 11.5 | 1450 [684.3] | 8051159 |
| | | RCF4824STAM | 40500 [11.9] | 30300 [8.9] | 10200 [3.0] | 13.5 | 11.5 | 1425 [672.5] | 8051192 |
| RA1342AJ1 | R801TA125524MSA | RCF4824HTAM | 42000 [12.3] | 29900 [8.8] | 12100 [3.5] | 14.5 | 12 | 1400 [660.7] | 7511826 |
| | | RCF4824STAM | 40500 [11.9] | 30000 [8.8] | 10500 [3.1] | 14 | 11.5 | 1350 [637.1] | 7511854 |
| RA1342AJ1 | R801TA125524MXA | RCF4824HTAM | 42000 [12.3] | 29900 [8.8] | 12100 [3.5] | 14.5 | 12 | 1400 [660.7] | 8051161 |
| | | RCF4824STAM | 40500 [11.9] | 30000 [8.8] | 10500 [3.1] | 14 | 11.5 | 1350 [637.1] | 8051194 |
| RA1342AJ1 | R801TA125524ZSA | RCF4824HTAM | 41500 [12.2] | 28100 [8.2] | 13400 [3.9] | 14.5 | 12 | 1150 [542.7] | 7511827 |
| | | RCF4824STAM | 39500 [11.6] | 27700 [8.1] | 11800 [3.5] | 14 | 11.5 | 1100 [519.1] | 7511855 |
| RA1342AJ1 | R801TA125524ZXA | RCF4824HTAM | 41500 [12.2] | 28100 [8.2] | 13400 [3.9] | 14.5 | 12 | 1150 [542.7] | 8051164 |
| | | RCF4824STAM | 39500 [11.6] | 27700 [8.1] | 11800 [3.5] | 14 | 11.5 | 1100 [519.1] | 8051197 |

[] Designates Metric Conversions

Performance Data @ AHRI Standard Conditions – Cooling (con't.)

| R801T: Classic Plus Single-Stage X-13 80% Furnace Ratings | | | | | | | | | |
|---|-----------------|-------------|------------------------------|----------------------------|--------------------------|------|------|---------------------|---------|
| Outdoor Unit | Furnace | Indoor Coil | Total Capacity BTU/H [kW] | Net Sensible BTU/H [kW] | Net Latent BTU/H [kW] | SEER | EER | Indoor CFM [L/s] | AHRI# |
| RA1348AC1 | R801TA075317ZSA | RCF4821MTAM | 47500 [13.9] | 31500 [9.2] | 16000 [4.7] | 13 | 11.5 | 1350 [637.1] | 8086711 |
| RA1348AC1 | R801TA075417MSA | RCF4821MTAM | 48000 [14.1] | 32300 [9.5] | 15700 [4.6] | 13.5 | 11.5 | 1400 [660.7] | 8086712 |
| | | RCF4821STAM | 47000 [13.8] | 32800 [9.6] | 14200 [4.2] | 13 | 11.5 | 1375 [648.9] | 7508924 |
| RA1348AC1 | R801TA075417MXA | RCF4821STAM | 47000 [13.8] | 32800 [9.6] | 14200 [4.2] | 13 | 11.5 | 1375 [648.9] | 8051333 |
| RA1348AC1 | R801TA075421MSA | RCF4821MTAM | 48000 [14.1] | 34400 [10.1] | 13600 [4.0] | 13.5 | 11.5 | 1425 [672.5] | 8086713 |
| | | RCF4821STAM | 47000 [13.8] | 33000 [9.7] | 14000 [4.1] | 13 | 11.5 | 1400 [660.7] | 8049173 |
| | | RCF4824HTAM | 48000 [14.1] | 34400 [10.1] | 13600 [4.0] | 13.5 | 11.5 | 1425 [672.5] | 8049178 |
| | | RCF4824STAM | 47000 [13.8] | 33000 [9.7] | 14000 [4.1] | 13 | 11.5 | 1400 [660.7] | 8049183 |
| RA1348AC1 | R801TA075421MXA | RCF4821STAM | 47000 [13.8] | 33000 [9.7] | 14000 [4.1] | 13 | 11.5 | 1400 [660.7] | 8051336 |
| | | RCF4824HTAM | 48000 [14.1] | 34400 [10.1] | 13600 [4.0] | 13.5 | 11.5 | 1425 [672.5] | 8051360 |
| | | RCF4824STAM | 47000 [13.8] | 33000 [9.7] | 14000 [4.1] | 13 | 11.5 | 1400 [660.7] | 8051392 |
| RA1348AC1 | R801TA075521ZSA | RCF4821MTAM | 48000 [14.1] | 34400 [10.1] | 13600 [4.0] | 13.5 | 11.5 | 1425 [672.5] | 8086714 |
| | | RCF4821STAM | 47000 [13.8] | 33000 [9.7] | 14000 [4.1] | 13 | 11.5 | 1400 [660.7] | 7508925 |
| | | RCF4824HTAM | 48000 [14.1] | 32300 [9.5] | 15700 [4.6] | 13.5 | 11.5 | 1450 [684.3] | 7508939 |
| | | RCF4824STAM | 47000 [13.8] | 33000 [9.7] | 14000 [4.1] | 13 | 11.5 | 1400 [660.7] | 7508970 |
| RA1348AC1 | R801TA075521ZXA | RCF4821STAM | 47000 [13.8] | 33000 [9.7] | 14000 [4.1] | 13 | 11.5 | 1400 [660.7] | 8051338 |
| | | RCF4824HTAM | 48000 [14.1] | 32300 [9.5] | 15700 [4.6] | 13.5 | 11.5 | 1450 [684.3] | 8051362 |
| | | RCF4824STAM | 47000 [13.8] | 33000 [9.7] | 14000 [4.1] | 13 | 11.5 | 1400 [660.7] | 8051394 |
| RA1348AC1 | R801TA100521MSA | RCF4821MTAM | 48000 [14.1] | 31800 [9.3] | 16200 [4.7] | 14 | 11.5 | 1325 [625.3] | 8086715 |
| | | RCF4821STAM | 47000 [13.8] | 32800 [9.6] | 14200 [4.2] | 13.5 | 11.5 | 1375 [648.9] | 7508926 |
| | | RCF4824HTAM | 48000 [14.1] | 32200 [9.4] | 15800 [4.6] | 14 | 11.5 | 1425 [672.5] | 7508940 |
| | | RCF4824STAM | 47000 [13.8] | 32800 [9.6] | 14200 [4.2] | 13.5 | 11.5 | 1375 [648.9] | 7508973 |
| RA1348AC1 | R801TA100521MXA | RCF4821STAM | 47000 [13.8] | 32800 [9.6] | 14200 [4.2] | 13.5 | 11.5 | 1375 [648.9] | 8051341 |
| | | RCF4824HTAM | 48000 [14.1] | 32200 [9.4] | 15800 [4.6] | 14 | 11.5 | 1425 [672.5] | 8051365 |
| | | RCF4824STAM | 47000 [13.8] | 32800 [9.6] | 14200 [4.2] | 13.5 | 11.5 | 1375 [648.9] | 8051396 |
| RA1348AC1 | R801TA100521ZSA | RCF4821MTAM | 48000 [14.1] | 34400 [10.1] | 13600 [4.0] | 13.5 | 11.5 | 1425 [672.5] | 8086716 |
| | | RCF4821STAM | 47000 [13.8] | 33000 [9.7] | 14000 [4.1] | 13 | 11.5 | 1400 [660.7] | 7508927 |
| | | RCF4824HTAM | 48000 [14.1] | 32200 [9.4] | 15800 [4.6] | 13.5 | 11.5 | 1425 [672.5] | 7508941 |
| | | RCF4824STAM | 47000 [13.8] | 33000 [9.7] | 14000 [4.1] | 13 | 11.5 | 1400 [660.7] | 7508975 |
| RA1348AC1 | R801TA100521ZXA | RCF4821STAM | 47000 [13.8] | 33000 [9.7] | 14000 [4.1] | 13 | 11.5 | 1400 [660.7] | 8051343 |
| | | RCF4824HTAM | 48000 [14.1] | 32200 [9.4] | 15800 [4.6] | 13.5 | 11.5 | 1425 [672.5] | 8051367 |
| | | RCF4824STAM | 47000 [13.8] | 33000 [9.7] | 14000 [4.1] | 13 | 11.5 | 1400 [660.7] | 8051398 |
| RA1348AC1 | R801TA125524MSA | RCF4824HTAM | 48000 [14.1] | 31800 [9.3] | 16200 [4.7] | 14 | 11.5 | 1375 [648.9] | 7508942 |
| | | RCF4824STAM | 47000 [13.8] | 32500 [9.5] | 14500 [4.2] | 13.5 | 11.5 | 1325 [625.3] | 7508977 |
| RA1348AC1 | R801TA125524MXA | RCF4824HTAM | 48000 [14.1] | 31800 [9.3] | 16200 [4.7] | 14 | 11.5 | 1375 [648.9] | 8051369 |
| | | RCF4824STAM | 47000 [13.8] | 32500 [9.5] | 14500 [4.2] | 13.5 | 11.5 | 1325 [625.3] | 8051400 |
| RA1348AC1 | R801TA125524ZSA | RCF4824HTAM | 48000 [14.1] | 31800 [9.3] | 16200 [4.7] | 13.5 | 11.5 | 1375 [648.9] | 7508943 |
| | | RCF4824STAM | 47000 [13.8] | 32500 [9.5] | 14500 [4.2] | 13 | 11.5 | 1325 [625.3] | 7508979 |
| RA1348AC1 | R801TA125524ZXA | RCF4824HTAM | 48000 [14.1] | 31800 [9.3] | 16200 [4.7] | 13.5 | 11.5 | 1375 [648.9] | 8051372 |
| | | RCF4824STAM | 47000 [13.8] | 32500 [9.5] | 14500 [4.2] | 13 | 11.5 | 1325 [625.3] | 8051402 |
| RA1348AJ1 | R801TA075317ZSA | RCF4821MTAM | 47500 [13.9] | 31500 [9.2] | 16000 [4.7] | 13 | 11.5 | 1350 [637.1] | 8086747 |
| RA1348AJ1 | R801TA075417MSA | RCF4821MTAM | 48000 [14.1] | 32300 [9.5] | 15700 [4.6] | 13.5 | 11.5 | 1400 [660.7] | 8086748 |
| | | RCF4821STAM | 47000 [13.8] | 32800 [9.6] | 14200 [4.2] | 13 | 11.5 | 1375 [648.9] | 7509149 |
| RA1348AJ1 | R801TA075417MXA | RCF4821STAM | 47000 [13.8] | 32800 [9.6] | 14200 [4.2] | 13 | 11.5 | 1375 [648.9] | 8051514 |
| RA1348AJ1 | R801TA075421MSA | RCF4821MTAM | 48000 [14.1] | 34400 [10.1] | 13600 [4.0] | 13.5 | 11.5 | 1425 [672.5] | 8086749 |
| | | RCF4821STAM | 47000 [13.8] | 33000 [9.7] | 14000 [4.1] | 13 | 11.5 | 1400 [660.7] | 8049208 |
| | | RCF4824HTAM | 48000 [14.1] | 34400 [10.1] | 13600 [4.0] | 13.5 | 11.5 | 1425 [672.5] | 8049213 |
| | | RCF4824STAM | 47000 [13.8] | 33000 [9.7] | 14000 [4.1] | 13 | 11.5 | 1400 [660.7] | 8049218 |

[] Designates Metric Conversions



Performance Data @ AHRI Standard Conditions – Cooling (con't.)

| R801T: Classic Plus Single-Stage X-13 80% Furnace Ratings | | | | | | | | | |
|---|-----------------|-------------|------------------------------|----------------------------|--------------------------|------|------|---------------------|---------|
| Outdoor Unit | Furnace | Indoor Coil | Total Capacity BTU/H [kW] | Net Sensible BTU/H [kW] | Net Latent BTU/H [kW] | SEER | EER | Indoor CFM [L/s] | AHRI# |
| RA1348AJ1 | R801TA075421MXA | RCF4821STAM | 47000 [13.8] | 33000 [9.7] | 14000 [4.1] | 13 | 11.5 | 1400 [660.7] | 8051517 |
| | | RCF4824HTAM | 48000 [14.1] | 34400 [10.1] | 13600 [4.0] | 13.5 | 11.5 | 1425 [672.5] | 8051541 |
| | | RCF4824STAM | 47000 [13.8] | 33000 [9.7] | 14000 [4.1] | 13 | 11.5 | 1400 [660.7] | 8051564 |
| RA1348AJ1 | R801TA075521ZSA | RCF4821MTAM | 48000 [14.1] | 34400 [10.1] | 13600 [4.0] | 13.5 | 11.5 | 1425 [672.5] | 8086750 |
| | | RCF4821STAM | 47000 [13.8] | 33000 [9.7] | 14000 [4.1] | 13 | 11.5 | 1400 [660.7] | 7509150 |
| | | RCF4824HTAM | 48000 [14.1] | 32300 [9.5] | 15700 [4.6] | 13.5 | 11.5 | 1450 [684.3] | 7509164 |
| | | RCF4824STAM | 47000 [13.8] | 33000 [9.7] | 14000 [4.1] | 13 | 11.5 | 1400 [660.7] | 7509189 |
| RA1348AJ1 | R801TA075521ZXA | RCF4821STAM | 47000 [13.8] | 33000 [9.7] | 14000 [4.1] | 13 | 11.5 | 1400 [660.7] | 8051520 |
| | | RCF4824HTAM | 48000 [14.1] | 32300 [9.5] | 15700 [4.6] | 13.5 | 11.5 | 1450 [684.3] | 8051543 |
| | | RCF4824STAM | 47000 [13.8] | 33000 [9.7] | 14000 [4.1] | 13 | 11.5 | 1400 [660.7] | 8051565 |
| RA1348AJ1 | R801TA100521MSA | RCF4821MTAM | 48000 [14.1] | 31800 [9.3] | 16200 [4.7] | 14 | 11.5 | 1325 [625.3] | 8086751 |
| | | RCF4821STAM | 47000 [13.8] | 32800 [9.6] | 14200 [4.2] | 13.5 | 11.5 | 1375 [648.9] | 7509151 |
| | | RCF4824HTAM | 48000 [14.1] | 32200 [9.4] | 15800 [4.6] | 14 | 11.5 | 1425 [672.5] | 7509165 |
| | | RCF4824STAM | 47000 [13.8] | 32800 [9.6] | 14200 [4.2] | 13.5 | 11.5 | 1375 [648.9] | 7509190 |
| RA1348AJ1 | R801TA100521MXA | RCF4821STAM | 47000 [13.8] | 32800 [9.6] | 14200 [4.2] | 13.5 | 11.5 | 1375 [648.9] | 8051522 |
| | | RCF4824HTAM | 48000 [14.1] | 32200 [9.4] | 15800 [4.6] | 14 | 11.5 | 1425 [672.5] | 8051546 |
| | | RCF4824STAM | 47000 [13.8] | 32800 [9.6] | 14200 [4.2] | 13.5 | 11.5 | 1375 [648.9] | 8051566 |
| RA1348AJ1 | R801TA100521ZSA | RCF4821MTAM | 48000 [14.1] | 34400 [10.1] | 13600 [4.0] | 13.5 | 11.5 | 1425 [672.5] | 8086752 |
| | | RCF4821STAM | 47000 [13.8] | 33000 [9.7] | 14000 [4.1] | 13 | 11.5 | 1400 [660.7] | 7509152 |
| | | RCF4824HTAM | 48000 [14.1] | 32200 [9.4] | 15800 [4.6] | 13.5 | 11.5 | 1425 [672.5] | 7509166 |
| | | RCF4824STAM | 47000 [13.8] | 33000 [9.7] | 14000 [4.1] | 13 | 11.5 | 1400 [660.7] | 7509191 |
| RA1348AJ1 | R801TA100521ZXA | RCF4821STAM | 47000 [13.8] | 33000 [9.7] | 14000 [4.1] | 13 | 11.5 | 1400 [660.7] | 8051524 |
| | | RCF4824HTAM | 48000 [14.1] | 32200 [9.4] | 15800 [4.6] | 13.5 | 11.5 | 1425 [672.5] | 8051548 |
| | | RCF4824STAM | 47000 [13.8] | 33000 [9.7] | 14000 [4.1] | 13 | 11.5 | 1400 [660.7] | 8051567 |
| RA1348AJ1 | R801TA125524MSA | RCF4824HTAM | 48000 [14.1] | 31800 [9.3] | 16200 [4.7] | 14 | 11.5 | 1375 [648.9] | 7509167 |
| | | RCF4824STAM | 47000 [13.8] | 32500 [9.5] | 14500 [4.2] | 13.5 | 11.5 | 1325 [625.3] | 7509192 |
| RA1348AJ1 | R801TA125524MXA | RCF4824HTAM | 48000 [14.1] | 31800 [9.3] | 16200 [4.7] | 14 | 11.5 | 1375 [648.9] | 8051551 |
| | | RCF4824STAM | 47000 [13.8] | 32500 [9.5] | 14500 [4.2] | 13.5 | 11.5 | 1325 [625.3] | 8051568 |
| RA1348AJ1 | R801TA125524ZSA | RCF4824HTAM | 48000 [14.1] | 31800 [9.3] | 16200 [4.7] | 13.5 | 11.5 | 1375 [648.9] | 7509168 |
| | | RCF4824STAM | 47000 [13.8] | 32500 [9.5] | 14500 [4.2] | 13 | 11.5 | 1325 [625.3] | 7509193 |
| RA1348AJ1 | R801TA125524ZXA | RCF4824HTAM | 48000 [14.1] | 31800 [9.3] | 16200 [4.7] | 13.5 | 11.5 | 1375 [648.9] | 8051553 |
| | | RCF4824STAM | 47000 [13.8] | 32500 [9.5] | 14500 [4.2] | 13 | 11.5 | 1325 [625.3] | 8051569 |
| RA1360AC1 | R801TA075417MSA | RCF6021STAM | 54000 [15.8] | 35600 [10.4] | 18400 [5.4] | 13 | 11 | 1475 [696.1] | 8086783 |
| RA1360AC1 | R801TA075421MSA | RCF6021STAM | 54500 [16.0] | 35400 [10.4] | 19100 [5.6] | 13 | 11 | 1425 [672.5] | 8086784 |
| | | RCF6024HTAM | 55500 [16.3] | 37900 [11.1] | 17600 [5.2] | 13.5 | 11.5 | 1425 [672.5] | 8049244 |
| | | RCF6024STAM | 55500 [16.3] | 37900 [11.1] | 17600 [5.2] | 13.5 | 11.5 | 1425 [672.5] | 8049249 |
| RA1360AC1 | R801TA075421MXA | RCF6021STAM | 54500 [16.0] | 35400 [10.4] | 19100 [5.6] | 13 | 11 | 1425 [672.5] | 8086785 |
| | | RCF6024HTAM | 55500 [16.3] | 37900 [11.1] | 17600 [5.2] | 13.5 | 11.5 | 1425 [672.5] | 8051619 |
| | | RCF6024STAM | 55500 [16.3] | 37900 [11.1] | 17600 [5.2] | 13.5 | 11.5 | 1425 [672.5] | 8051646 |
| RA1360AC1 | R801TA075521ZSA | RCF6024HTAM | 56000 [16.4] | 38500 [11.3] | 17500 [5.1] | 13 | 11 | 1450 [684.3] | 7509291 |
| | | RCF6024STAM | 56000 [16.4] | 38500 [11.3] | 17500 [5.1] | 13 | 11 | 1450 [684.3] | 7509315 |
| RA1360AC1 | R801TA075521ZXA | RCF6024HTAM | 56000 [16.4] | 38500 [11.3] | 17500 [5.1] | 13 | 11 | 1450 [684.3] | 8051621 |
| | | RCF6024STAM | 56000 [16.4] | 38500 [11.3] | 17500 [5.1] | 13 | 11 | 1450 [684.3] | 8051647 |
| RA1360AC1 | R801TA100521MSA | RCF6021STAM | 56000 [16.4] | 40400 [11.8] | 15600 [4.6] | 13 | 11 | 1850 [873.1] | 8086786 |
| | | RCF6024HTAM | 57000 [16.7] | 41100 [12.0] | 15900 [4.7] | 13.5 | 11.5 | 1650 [778.7] | 7509292 |
| | | RCF6024STAM | 57000 [16.7] | 41100 [12.0] | 15900 [4.7] | 13.5 | 11.5 | 1650 [778.7] | 7509316 |
| RA1360AC1 | R801TA100521MXA | RCF6024HTAM | 57000 [16.7] | 41100 [12.0] | 15900 [4.7] | 13.5 | 11.5 | 1650 [778.7] | 8051623 |
| | | RCF6024STAM | 57000 [16.7] | 41100 [12.0] | 15900 [4.7] | 13.5 | 11.5 | 1650 [778.7] | 8051648 |

[] Designates Metric Conversions

Performance Data @ AHRI Standard Conditions – Cooling (con't.)

| R801T: Classic Plus Single-Stage X-13 80% Furnace Ratings | | | | | | | | | |
|---|-----------------|-------------|------------------------------|----------------------------|--------------------------|------|------|---------------------|---------|
| Outdoor Unit | Furnace | Indoor Coil | Total Capacity BTU/H [kW] | Net Sensible BTU/H [kW] | Net Latent BTU/H [kW] | SEER | EER | Indoor CFM [L/s] | AHRI# |
| RA1360AC1 | R801TA100521ZSA | RCF6024HTAM | 57000 [16.7] | 41500 [12.2] | 15500 [4.5] | 13 | 11 | 1700 [802.3] | 7509293 |
| | | RCF6024STAM | 57000 [16.7] | 41500 [12.2] | 15500 [4.5] | 13 | 11 | 1700 [802.3] | 7509317 |
| RA1360AC1 | R801TA100521ZXA | RCF6024HTAM | 57000 [16.7] | 41500 [12.2] | 15500 [4.5] | 13 | 11 | 1700 [802.3] | 8051625 |
| | | RCF6024STAM | 57000 [16.7] | 41500 [12.2] | 15500 [4.5] | 13 | 11 | 1700 [802.3] | 8051649 |
| RA1360AC1 | R801TA125524MSA | RCF6024HTAM | 57000 [16.7] | 41100 [12.0] | 15900 [4.7] | 13.5 | 11.5 | 1650 [778.7] | 7509294 |
| | | RCF6024STAM | 57000 [16.7] | 41100 [12.0] | 15900 [4.7] | 13.5 | 11.5 | 1650 [778.7] | 7509318 |
| RA1360AC1 | R801TA125524MXA | RCF6024HTAM | 57000 [16.7] | 41100 [12.0] | 15900 [4.7] | 13.5 | 11.5 | 1650 [778.7] | 8051627 |
| | | RCF6024STAM | 57000 [16.7] | 41100 [12.0] | 15900 [4.7] | 13.5 | 11.5 | 1650 [778.7] | 8051650 |
| RA1360AC1 | R801TA125524ZSA | RCF6024HTAM | 57000 [16.7] | 41300 [12.1] | 15700 [4.6] | 13 | 11 | 1675 [790.5] | 7509295 |
| | | RCF6024STAM | 57000 [16.7] | 41300 [12.1] | 15700 [4.6] | 13 | 11 | 1675 [790.5] | 7509319 |
| RA1360AC1 | R801TA125524ZXA | RCF6024HTAM | 57000 [16.7] | 41300 [12.1] | 15700 [4.6] | 13 | 11 | 1675 [790.5] | 8051629 |
| | | RCF6024STAM | 57000 [16.7] | 41300 [12.1] | 15700 [4.6] | 13 | 11 | 1675 [790.5] | 8051651 |
| RA1360AJ1 | R801TA075417MSA | RCF6021STAM | 54000 [15.8] | 35600 [10.4] | 18400 [5.4] | 13 | 11 | 1475 [696.1] | 8086801 |
| RA1360AJ1 | R801TA075421MSA | RCF6021STAM | 54500 [16.0] | 35400 [10.4] | 19100 [5.6] | 13 | 11 | 1425 [672.5] | 8086802 |
| | | RCF6024HTAM | 55500 [16.3] | 37900 [11.1] | 17600 [5.2] | 13.5 | 11.5 | 1425 [672.5] | 8049275 |
| | | RCF6024STAM | 55500 [16.3] | 37900 [11.1] | 17600 [5.2] | 13.5 | 11.5 | 1425 [672.5] | 8049280 |
| RA1360AJ1 | R801TA075421MXA | RCF6021STAM | 54500 [16.0] | 35400 [10.4] | 19100 [5.6] | 13 | 11 | 1425 [672.5] | 8086803 |
| | | RCF6024HTAM | 55500 [16.3] | 37900 [11.1] | 17600 [5.2] | 13.5 | 11.5 | 1425 [672.5] | 8051688 |
| | | RCF6024STAM | 55500 [16.3] | 37900 [11.1] | 17600 [5.2] | 13.5 | 11.5 | 1425 [672.5] | 8051700 |
| RA1360AJ1 | R801TA075521ZSA | RCF6024HTAM | 56000 [16.4] | 38500 [11.3] | 17500 [5.1] | 13 | 11 | 1450 [684.3] | 7509413 |
| | | RCF6024STAM | 56000 [16.4] | 38500 [11.3] | 17500 [5.1] | 13 | 11 | 1450 [684.3] | 7509437 |
| RA1360AJ1 | R801TA075521ZXA | RCF6024HTAM | 56000 [16.4] | 38500 [11.3] | 17500 [5.1] | 13 | 11 | 1450 [684.3] | 8051689 |
| | | RCF6024STAM | 56000 [16.4] | 38500 [11.3] | 17500 [5.1] | 13 | 11 | 1450 [684.3] | 8051701 |
| RA1360AJ1 | R801TA100521MSA | RCF6021STAM | 56000 [16.4] | 40400 [11.8] | 15600 [4.6] | 13 | 11 | 1850 [873.1] | 8086804 |
| | | RCF6024HTAM | 57000 [16.7] | 41100 [12.0] | 15900 [4.7] | 13.5 | 11.5 | 1650 [778.7] | 7509414 |
| | | RCF6024STAM | 57000 [16.7] | 41100 [12.0] | 15900 [4.7] | 13.5 | 11.5 | 1650 [778.7] | 7509438 |
| RA1360AJ1 | R801TA100521MXA | RCF6024HTAM | 57000 [16.7] | 41100 [12.0] | 15900 [4.7] | 13.5 | 11.5 | 1650 [778.7] | 8051690 |
| | | RCF6024STAM | 57000 [16.7] | 41100 [12.0] | 15900 [4.7] | 13.5 | 11.5 | 1650 [778.7] | 8051702 |
| RA1360AJ1 | R801TA100521ZSA | RCF6024HTAM | 57000 [16.7] | 41500 [12.2] | 15500 [4.5] | 13 | 11 | 1700 [802.3] | 7509415 |
| | | RCF6024STAM | 57000 [16.7] | 41500 [12.2] | 15500 [4.5] | 13 | 11 | 1700 [802.3] | 7509439 |
| RA1360AJ1 | R801TA100521ZXA | RCF6024HTAM | 57000 [16.7] | 41500 [12.2] | 15500 [4.5] | 13 | 11 | 1700 [802.3] | 8051691 |
| | | RCF6024STAM | 57000 [16.7] | 41500 [12.2] | 15500 [4.5] | 13 | 11 | 1700 [802.3] | 8051703 |
| RA1360AJ1 | R801TA125524MSA | RCF6024HTAM | 57000 [16.7] | 41100 [12.0] | 15900 [4.7] | 13.5 | 11.5 | 1650 [778.7] | 7509416 |
| | | RCF6024STAM | 57000 [16.7] | 41100 [12.0] | 15900 [4.7] | 13.5 | 11.5 | 1650 [778.7] | 7509440 |
| RA1360AJ1 | R801TA125524MXA | RCF6024HTAM | 57000 [16.7] | 41100 [12.0] | 15900 [4.7] | 13.5 | 11.5 | 1650 [778.7] | 8051692 |
| | | RCF6024STAM | 57000 [16.7] | 41100 [12.0] | 15900 [4.7] | 13.5 | 11.5 | 1650 [778.7] | 8051704 |
| RA1360AJ1 | R801TA125524ZSA | RCF6024HTAM | 57000 [16.7] | 41300 [12.1] | 15700 [4.6] | 13 | 11 | 1675 [790.5] | 7509417 |
| | | RCF6024STAM | 57000 [16.7] | 41300 [12.1] | 15700 [4.6] | 13 | 11 | 1675 [790.5] | 7509441 |
| RA1360AJ1 | R801TA125524ZXA | RCF6024HTAM | 57000 [16.7] | 41300 [12.1] | 15700 [4.6] | 13 | 11 | 1675 [790.5] | 8051693 |
| | | RCF6024STAM | 57000 [16.7] | 41300 [12.1] | 15700 [4.6] | 13 | 11 | 1675 [790.5] | 8051705 |

[] Designates Metric Conversions

Performance Data @ AHRI Standard Conditions – Cooling (con't.)

| R802V: Prestige 2-Stage 80% ECM Furnace Ratings | | | | | | | | | |
|---|-----------------|-------------|------------------------------|----------------------------|--------------------------|------|------|---------------------|---------|
| Outdoor Unit | Furnace | Indoor Coil | Total Capacity BTU/H [kW] | Net Sensible BTU/H [kW] | Net Latent BTU/H [kW] | SEER | EER | Indoor CFM [L/s] | AHRI# |
| RA1318AJ1 | R802VA050317MSA | RCF2417HTAM | 18000 [5.3] | 13400 [3.9] | 4600 [1.3] | 14.5 | 12 | 675 [318.6] | 7982141 |
| | | RCF2417MTAM | 18000 [5.3] | 13400 [3.9] | 4600 [1.3] | 14.5 | 12 | 675 [318.6] | 7982150 |
| | | RCF2417STAM | 18000 [5.3] | 13400 [3.9] | 4600 [1.3] | 14.5 | 12 | 675 [318.6] | 7982159 |
| | | RCF2421MTAM | 18000 [5.3] | 13400 [3.9] | 4600 [1.3] | 14.5 | 12 | 675 [318.6] | 7982178 |
| RA1318AJ1 | R802VA050317MXA | RCF2417HTAM | 18000 [5.3] | 13400 [3.9] | 4600 [1.3] | 14.5 | 12 | 675 [318.6] | 8050157 |
| | | RCF2417MTAM | 18000 [5.3] | 13400 [3.9] | 4600 [1.3] | 14.5 | 12 | 675 [318.6] | 8050164 |
| | | RCF2417STAM | 18000 [5.3] | 13400 [3.9] | 4600 [1.3] | 14.5 | 12 | 675 [318.6] | 8050171 |
| | | RCF2421MTAM | 18000 [5.3] | 13400 [3.9] | 4600 [1.3] | 14.5 | 12 | 675 [318.6] | 8050184 |
| RA1318AJ1 | R802VA075317MSA | RCF2417HTAM | 18000 [5.3] | 13400 [3.9] | 4600 [1.3] | 14.5 | 12 | 675 [318.6] | 7982144 |
| | | RCF2417MTAM | 18000 [5.3] | 13400 [3.9] | 4600 [1.3] | 14.5 | 12 | 675 [318.6] | 7982152 |
| | | RCF2417STAM | 18000 [5.3] | 13400 [3.9] | 4600 [1.3] | 14.5 | 12 | 675 [318.6] | 7982162 |
| | | RCF2421MTAM | 18000 [5.3] | 13400 [3.9] | 4600 [1.3] | 14.5 | 12 | 675 [318.6] | 7982180 |
| RA1318AJ1 | R802VA075317MXA | RCF2417HTAM | 18000 [5.3] | 13400 [3.9] | 4600 [1.3] | 14.5 | 12 | 675 [318.6] | 8050158 |
| | | RCF2417MTAM | 18000 [5.3] | 13400 [3.9] | 4600 [1.3] | 14.5 | 12 | 675 [318.6] | 8050165 |
| | | RCF2417STAM | 18000 [5.3] | 13400 [3.9] | 4600 [1.3] | 14.5 | 12 | 675 [318.6] | 8050172 |
| | | RCF2421MTAM | 18000 [5.3] | 13400 [3.9] | 4600 [1.3] | 14.5 | 12 | 675 [318.6] | 8050185 |
| RA1318AJ1 | R802VA075317ZSA | RCF2417HTAM | 18000 [5.3] | 13400 [3.9] | 4600 [1.3] | 14.5 | 12 | 675 [318.6] | 7982146 |
| | | RCF2417MTAM | 18000 [5.3] | 13400 [3.9] | 4600 [1.3] | 14.5 | 12 | 675 [318.6] | 7982155 |
| | | RCF2417STAM | 18000 [5.3] | 13400 [3.9] | 4600 [1.3] | 14.5 | 12 | 675 [318.6] | 7982164 |
| | | RCF2421MTAM | 18000 [5.3] | 13400 [3.9] | 4600 [1.3] | 14.5 | 12 | 675 [318.6] | 7982182 |
| RA1318AJ1 | R802VA075317ZXA | RCF2417HTAM | 18000 [5.3] | 13400 [3.9] | 4600 [1.3] | 14.5 | 12 | 675 [318.6] | 8050159 |
| | | RCF2417MTAM | 18000 [5.3] | 13400 [3.9] | 4600 [1.3] | 14.5 | 12 | 675 [318.6] | 8050166 |
| | | RCF2417STAM | 18000 [5.3] | 13400 [3.9] | 4600 [1.3] | 14.5 | 12 | 675 [318.6] | 8050173 |
| | | RCF2421MTAM | 18000 [5.3] | 13400 [3.9] | 4600 [1.3] | 14.5 | 12 | 675 [318.6] | 8050186 |
| RA1318AJ1 | R802VA075421MSA | RCF2421MTAM | 18000 [5.3] | 13400 [3.9] | 4600 [1.3] | 15 | 12.5 | 650 [306.8] | 8048993 |
| RA1318AJ1 | R802VA075421MXA | RCF2421MTAM | 18000 [5.3] | 13400 [3.9] | 4600 [1.3] | 15 | 12.5 | 650 [306.8] | 8050187 |
| RA1318AJ1 | R802VA050317MSA | RCF2421HTAM | 18000 [5.3] | 13400 [3.9] | 4600 [1.3] | 14.5 | 12 | 675 [318.6] | 7982168 |
| RA1318AJ1 | R802VA050317MXA | RCF2421HTAM | 18000 [5.3] | 13400 [3.9] | 4600 [1.3] | 14.5 | 12 | 675 [318.6] | 8050177 |
| RA1318AJ1 | R802VA075317MSA | RCF2421HTAM | 18000 [5.3] | 13400 [3.9] | 4600 [1.3] | 14.5 | 12 | 675 [318.6] | 7982171 |
| RA1318AJ1 | R802VA075317MXA | RCF2421HTAM | 18000 [5.3] | 13400 [3.9] | 4600 [1.3] | 14.5 | 12 | 675 [318.6] | 8050178 |
| RA1318AJ1 | R802VA075317ZSA | RCF2421HTAM | 18000 [5.3] | 13400 [3.9] | 4600 [1.3] | 14.5 | 12 | 675 [318.6] | 7982173 |
| RA1318AJ1 | R802VA075317ZXA | RCF2421HTAM | 18000 [5.3] | 13400 [3.9] | 4600 [1.3] | 14.5 | 12 | 675 [318.6] | 8050179 |
| RA1318AJ1 | R802VA075421MSA | RCF2421HTAM | 18000 [5.3] | 13400 [3.9] | 4600 [1.3] | 15 | 12.5 | 650 [306.8] | 8048992 |
| RA1318AJ1 | R802VA075421MXA | RCF2421HTAM | 18000 [5.3] | 13400 [3.9] | 4600 [1.3] | 15 | 12.5 | 650 [306.8] | 8050180 |
| RA1324AJ1 | R802VA050317MSA | RCF2417HTAM | 24000 [7.0] | 17900 [5.2] | 6100 [1.8] | 14 | 11.5 | 875 [413.0] | 7982239 |
| | | RCF2417MTAM | 24000 [7.0] | 17300 [5.1] | 6700 [2.0] | 14 | 11.5 | 850 [401.2] | 7982248 |
| | | RCF2417STAM | 23800 [7.0] | 17800 [5.2] | 6000 [1.8] | 14 | 11.5 | 775 [365.8] | 7982257 |
| | | RCF2421MTAM | 24000 [7.0] | 17300 [5.1] | 6700 [2.0] | 14 | 11.5 | 850 [401.2] | 7982277 |
| RA1324AJ1 | R802VA050317MXA | RCF2417HTAM | 24000 [7.0] | 17900 [5.2] | 6100 [1.8] | 14 | 11.5 | 875 [413.0] | 8050234 |
| | | RCF2417MTAM | 24000 [7.0] | 17300 [5.1] | 6700 [2.0] | 14 | 11.5 | 850 [401.2] | 8050241 |
| | | RCF2417STAM | 23800 [7.0] | 17800 [5.2] | 6000 [1.8] | 14 | 11.5 | 775 [365.8] | 8050248 |
| | | RCF2421MTAM | 24000 [7.0] | 17300 [5.1] | 6700 [2.0] | 14 | 11.5 | 850 [401.2] | 8050264 |
| RA1324AJ1 | R802VA075317MSA | RCF2417HTAM | 24000 [7.0] | 17900 [5.2] | 6100 [1.8] | 14.5 | 12 | 875 [413.0] | 7982241 |
| | | RCF2417MTAM | 24000 [7.0] | 17900 [5.2] | 6100 [1.8] | 14.5 | 12 | 850 [401.2] | 7982250 |
| | | RCF2417STAM | 24000 [7.0] | 17900 [5.2] | 6100 [1.8] | 14 | 11.5 | 875 [413.0] | 7982259 |
| | | RCF2421MTAM | 24000 [7.0] | 17900 [5.2] | 6100 [1.8] | 14.5 | 12 | 850 [401.2] | 7982278 |

[] Designates Metric Conversions

Performance Data @ AHRI Standard Conditions – Cooling (con't.)

| R802V: Prestige 2-Stage 80% ECM Furnace Ratings | | | | | | | | | |
|---|-----------------|-------------|------------------------------|----------------------------|--------------------------|------|------|---------------------|---------|
| Outdoor Unit | Furnace | Indoor Coil | Total Capacity BTU/H [kW] | Net Sensible BTU/H [kW] | Net Latent BTU/H [kW] | SEER | EER | Indoor CFM [L/s] | AHRI# |
| RA1324AJ1 | R802VA075317MXA | RCF2417HTAM | 24000 [7.0] | 17900 [5.2] | 6100 [1.8] | 14.5 | 12 | 875 [413.0] | 8050235 |
| | | RCF2417MTAM | 24000 [7.0] | 17900 [5.2] | 6100 [1.8] | 14.5 | 12 | 850 [401.2] | 8050242 |
| | | RCF2417STAM | 24000 [7.0] | 17900 [5.2] | 6100 [1.8] | 14 | 11.5 | 875 [413.0] | 8050250 |
| | | RCF2421MTAM | 24000 [7.0] | 17900 [5.2] | 6100 [1.8] | 14.5 | 12 | 850 [401.2] | 8050265 |
| RA1324AJ1 | R802VA075317ZSA | RCF2417HTAM | 23600 [6.9] | 16500 [4.8] | 7100 [2.1] | 14.5 | 12 | 725 [342.2] | 7982243 |
| | | RCF2417MTAM | 24000 [7.0] | 17900 [5.2] | 6100 [1.8] | 14 | 11.5 | 875 [413.0] | 7982252 |
| | | RCF2417STAM | 24000 [7.0] | 17900 [5.2] | 6100 [1.8] | 14 | 11.5 | 875 [413.0] | 7982262 |
| | | RCF2421MTAM | 24000 [7.0] | 17900 [5.2] | 6100 [1.8] | 14 | 11.5 | 875 [413.0] | 7982279 |
| RA1324AJ1 | R802VA075317ZXA | RCF2417HTAM | 23600 [6.9] | 16500 [4.8] | 7100 [2.1] | 14.5 | 12 | 725 [342.2] | 8050236 |
| | | RCF2417MTAM | 24000 [7.0] | 17900 [5.2] | 6100 [1.8] | 14 | 11.5 | 875 [413.0] | 8050243 |
| | | RCF2417STAM | 24000 [7.0] | 17900 [5.2] | 6100 [1.8] | 14 | 11.5 | 875 [413.0] | 8050251 |
| | | RCF2421MTAM | 24000 [7.0] | 17900 [5.2] | 6100 [1.8] | 14 | 11.5 | 875 [413.0] | 8050266 |
| RA1324AJ1 | R802VA075421MSA | RCF2421MTAM | 24000 [7.0] | 17900 [5.2] | 6100 [1.8] | 14.5 | 12 | 850 [401.2] | 8049001 |
| RA1324AJ1 | R802VA075421MXA | RCF2421MTAM | 24000 [7.0] | 17900 [5.2] | 6100 [1.8] | 14.5 | 12 | 850 [401.2] | 8050267 |
| RA1324AJ1 | R802VA075421ZSA | RCF2421MTAM | 24000 [7.0] | 17900 [5.2] | 6100 [1.8] | 14 | 11.5 | 875 [413.0] | 7982280 |
| RA1324AJ1 | R802VA075421ZXA | RCF2421MTAM | 24000 [7.0] | 17900 [5.2] | 6100 [1.8] | 14 | 11.5 | 875 [413.0] | 8050268 |
| RA1324AJ1 | R802VA100521MSA | RCF2421MTAM | 24000 [7.0] | 17900 [5.2] | 6100 [1.8] | 14.5 | 12 | 850 [401.2] | 7982281 |
| RA1324AJ1 | R802VA100521MXA | RCF2421MTAM | 24000 [7.0] | 17900 [5.2] | 6100 [1.8] | 14.5 | 12 | 850 [401.2] | 8050269 |
| RA1324AJ1 | R802VA050317MSA | RCF2421HTAM | 24000 [7.0] | 17300 [5.1] | 6700 [2.0] | 14 | 11.5 | 850 [401.2] | 7982266 |
| RA1324AJ1 | R802VA050317MXA | RCF2421HTAM | 24000 [7.0] | 17300 [5.1] | 6700 [2.0] | 14 | 11.5 | 850 [401.2] | 8050255 |
| RA1324AJ1 | R802VA075317MSA | RCF2421HTAM | 24000 [7.0] | 17900 [5.2] | 6100 [1.8] | 14.5 | 12 | 850 [401.2] | 7982269 |
| RA1324AJ1 | R802VA075317MXA | RCF2421HTAM | 24000 [7.0] | 17900 [5.2] | 6100 [1.8] | 14.5 | 12 | 850 [401.2] | 8050256 |
| RA1324AJ1 | R802VA075317ZSA | RCF2421HTAM | 24000 [7.0] | 17900 [5.2] | 6100 [1.8] | 14 | 11.5 | 875 [413.0] | 7982271 |
| RA1324AJ1 | R802VA075317ZXA | RCF2421HTAM | 24000 [7.0] | 17900 [5.2] | 6100 [1.8] | 14 | 11.5 | 875 [413.0] | 8050257 |
| RA1324AJ1 | R802VA075421MSA | RCF2421HTAM | 24000 [7.0] | 17900 [5.2] | 6100 [1.8] | 14.5 | 12 | 850 [401.2] | 8048999 |
| RA1324AJ1 | R802VA075421MXA | RCF2421HTAM | 24000 [7.0] | 17900 [5.2] | 6100 [1.8] | 14.5 | 12 | 850 [401.2] | 8050258 |
| RA1324AJ1 | R802VA075421ZSA | RCF2421HTAM | 24000 [7.0] | 17900 [5.2] | 6100 [1.8] | 14 | 11.5 | 875 [413.0] | 7982273 |
| RA1324AJ1 | R802VA075421ZXA | RCF2421HTAM | 24000 [7.0] | 17900 [5.2] | 6100 [1.8] | 14 | 11.5 | 875 [413.0] | 8050259 |
| RA1324AJ1 | R802VA100521MSA | RCF2421HTAM | 24000 [7.0] | 17900 [5.2] | 6100 [1.8] | 14.5 | 12 | 850 [401.2] | 7982275 |
| RA1324AJ1 | R802VA100521MXA | RCF2421HTAM | 24000 [7.0] | 17900 [5.2] | 6100 [1.8] | 14.5 | 12 | 850 [401.2] | 8050260 |
| RA1330AJ1 | R802VA050317MSA | RCF3617STAM | 28000 [8.2] | 20500 [6.0] | 7500 [2.2] | 14 | 11.5 | 800 [377.6] | 7982307 |
| | | RCF3621HTAM | 29800 [8.7] | 21300 [6.2] | 8500 [2.5] | 15 | 12.5 | 800 [377.6] | 8086519 |
| | | RCF3621MTAM | 29800 [8.7] | 21400 [6.3] | 8400 [2.5] | 14.5 | 12 | 875 [413.0] | 7982311 |
| | | RCF3621STAM | 28200 [8.3] | 20900 [6.1] | 7300 [2.1] | 14 | 11.5 | 850 [401.2] | 7982318 |
| RA1330AJ1 | R802VA050317MXA | RCF3617STAM | 28000 [8.2] | 20500 [6.0] | 7500 [2.2] | 14 | 11.5 | 800 [377.6] | 8050316 |
| | | RCF3621MTAM | 29800 [8.7] | 21400 [6.3] | 8400 [2.5] | 14.5 | 12 | 875 [413.0] | 8050326 |
| | | RCF3621STAM | 28200 [8.3] | 20900 [6.1] | 7300 [2.1] | 14 | 11.5 | 850 [401.2] | 8050340 |
| RA1330AJ1 | R802VA075317MSA | RCF3617STAM | 29000 [8.5] | 22300 [6.5] | 6700 [2.0] | 14 | 11.5 | 1025 [483.7] | 7982308 |
| | | RCF3621HTAM | 30000 [8.8] | 22900 [6.7] | 7100 [2.1] | 15.1 | 12.5 | 1075 [507.3] | 8086520 |
| | | RCF3621MTAM | 30000 [8.8] | 22900 [6.7] | 7100 [2.1] | 14.5 | 12 | 1075 [507.3] | 7982312 |
| | | RCF3621STAM | 29000 [8.5] | 22300 [6.5] | 6700 [2.0] | 14 | 11.5 | 1025 [483.7] | 7982319 |
| RA1330AJ1 | R802VA075317MXA | RCF3617STAM | 29000 [8.5] | 22300 [6.5] | 6700 [2.0] | 14 | 11.5 | 1025 [483.7] | 8050317 |
| | | RCF3621MTAM | 30000 [8.8] | 22900 [6.7] | 7100 [2.1] | 14.5 | 12 | 1075 [507.3] | 8050327 |
| | | RCF3621STAM | 29000 [8.5] | 22300 [6.5] | 6700 [2.0] | 14 | 11.5 | 1025 [483.7] | 8050341 |
| RA1330AJ1 | R802VA075317ZSA | RCF3617STAM | 28400 [8.3] | 21300 [6.2] | 7100 [2.1] | 14 | 11.5 | 900 [424.8] | 7982309 |
| | | RCF3621MTAM | 30000 [8.8] | 22900 [6.7] | 7100 [2.1] | 14.5 | 12 | 1050 [495.5] | 7982313 |
| | | RCF3621STAM | 28600 [8.4] | 21500 [6.3] | 7100 [2.1] | 14 | 11.5 | 900 [424.8] | 7982320 |

[] Designates Metric Conversions

Performance Data @ AHRI Standard Conditions – Cooling (con't.)

| R802V: Prestige 2-Stage 80% ECM Furnace Ratings | | | | | | | | | |
|---|-----------------|-------------|------------------------------|----------------------------|--------------------------|------|------|---------------------|---------|
| Outdoor Unit | Furnace | Indoor Coil | Total Capacity BTU/H [kW] | Net Sensible BTU/H [kW] | Net Latent BTU/H [kW] | SEER | EER | Indoor CFM [L/s] | AHRI# |
| RA1330AJ1 | R802VA075317ZXA | RCF3617STAM | 28400 [8.3] | 21300 [6.2] | 7100 [2.1] | 14 | 11.5 | 900 [424.8] | 8050318 |
| | | RCF3621MTAM | 30000 [8.8] | 22900 [6.7] | 7100 [2.1] | 14.5 | 12 | 1050 [495.5] | 8050328 |
| | | RCF3621STAM | 28600 [8.4] | 21500 [6.3] | 7100 [2.1] | 14 | 11.5 | 900 [424.8] | 8050342 |
| RA1330AJ1 | R802VA075421MSA | RCF3621HTAM | 30000 [8.8] | 22900 [6.7] | 7100 [2.1] | 15.1 | 12.5 | 1075 [507.3] | 8086521 |
| | | RCF3621MTAM | 30000 [8.8] | 22900 [6.7] | 7100 [2.1] | 15 | 12.5 | 1000 [471.9] | 8049011 |
| | | RCF3621STAM | 29200 [8.6] | 22500 [6.6] | 6700 [2.0] | 14 | 11.5 | 1025 [483.7] | 8049015 |
| | | RCF3624MTAM | 30000 [8.8] | 22900 [6.7] | 7100 [2.1] | 15 | 12.5 | 1000 [471.9] | 8049019 |
| RA1330AJ1 | R802VA075421MXA | RCF3621HTAM | 30000 [8.8] | 22900 [6.7] | 7100 [2.1] | 15.1 | 12.5 | 1075 [507.3] | 8086522 |
| | | RCF3621MTAM | 30000 [8.8] | 22900 [6.7] | 7100 [2.1] | 15 | 12.5 | 1000 [471.9] | 8050329 |
| | | RCF3621STAM | 29200 [8.6] | 22500 [6.6] | 6700 [2.0] | 14 | 11.5 | 1025 [483.7] | 8050343 |
| | | RCF3624MTAM | 30000 [8.8] | 22900 [6.7] | 7100 [2.1] | 15 | 12.5 | 1000 [471.9] | 8050362 |
| RA1330AJ1 | R802VA075421ZSA | RCF3621MTAM | 30000 [8.8] | 22900 [6.7] | 7100 [2.1] | 14.5 | 12 | 1075 [507.3] | 7982314 |
| | | RCF3621STAM | 29000 [8.5] | 22300 [6.5] | 6700 [2.0] | 14 | 11.5 | 1025 [483.7] | 7982321 |
| | | RCF3624HTAM | 30000 [8.8] | 22900 [6.7] | 7100 [2.1] | 15.1 | 12.5 | 1075 [507.3] | 7982325 |
| | | RCF3624MTAM | 30000 [8.8] | 22900 [6.7] | 7100 [2.1] | 14.5 | 12 | 1075 [507.3] | 7982330 |
| RA1330AJ1 | R802VA075421ZXA | RCF3621MTAM | 30000 [8.8] | 22900 [6.7] | 7100 [2.1] | 14.5 | 12 | 1075 [507.3] | 8050330 |
| | | RCF3621STAM | 29000 [8.5] | 22300 [6.5] | 6700 [2.0] | 14 | 11.5 | 1025 [483.7] | 8050344 |
| | | RCF3624HTAM | 30000 [8.8] | 22900 [6.7] | 7100 [2.1] | 15.1 | 12.5 | 1075 [507.3] | 8050352 |
| | | RCF3624MTAM | 30000 [8.8] | 22900 [6.7] | 7100 [2.1] | 14.5 | 12 | 1075 [507.3] | 8050363 |
| RA1330AJ1 | R802VA100521MSA | RCF3621HTAM | 30000 [8.8] | 22900 [6.7] | 7100 [2.1] | 15.5 | 13 | 1025 [483.7] | 8086523 |
| | | RCF3621MTAM | 30000 [8.8] | 22900 [6.7] | 7100 [2.1] | 15.1 | 12.5 | 1025 [483.7] | 7982315 |
| | | RCF3621STAM | 29200 [8.6] | 22500 [6.6] | 6700 [2.0] | 14.5 | 12 | 1025 [483.7] | 7982322 |
| | | RCF3624HTAM | 30000 [8.8] | 22900 [6.7] | 7100 [2.1] | 15.5 | 13 | 1025 [483.7] | 7982326 |
| | | RCF3624MTAM | 30000 [8.8] | 22900 [6.7] | 7100 [2.1] | 15.1 | 12.5 | 1025 [483.7] | 7982331 |
| RA1330AJ1 | R802VA100521MXA | RCF3621MTAM | 30000 [8.8] | 22900 [6.7] | 7100 [2.1] | 15.1 | 12.5 | 1025 [483.7] | 8050331 |
| | | RCF3621STAM | 29200 [8.6] | 22500 [6.6] | 6700 [2.0] | 14.5 | 12 | 1025 [483.7] | 8050345 |
| | | RCF3624HTAM | 30000 [8.8] | 22900 [6.7] | 7100 [2.1] | 15.5 | 13 | 1025 [483.7] | 8050353 |
| | | RCF3624MTAM | 30000 [8.8] | 22900 [6.7] | 7100 [2.1] | 15.1 | 12.5 | 1025 [483.7] | 8050364 |
| RA1330AJ1 | R802VA100521ZSA | RCF3621MTAM | 30000 [8.8] | 22900 [6.7] | 7100 [2.1] | 14.5 | 12 | 1050 [495.5] | 7982316 |
| | | RCF3621STAM | 29000 [8.5] | 22100 [6.5] | 6900 [2.0] | 14 | 11.5 | 975 [460.1] | 7982323 |
| | | RCF3624HTAM | 30000 [8.8] | 22900 [6.7] | 7100 [2.1] | 15.5 | 13 | 975 [460.1] | 7982327 |
| | | RCF3624MTAM | 30000 [8.8] | 22900 [6.7] | 7100 [2.1] | 14.5 | 12 | 1050 [495.5] | 7982332 |
| RA1330AJ1 | R802VA100521ZXA | RCF3621MTAM | 30000 [8.8] | 22900 [6.7] | 7100 [2.1] | 14.5 | 12 | 1050 [495.5] | 8050332 |
| | | RCF3621STAM | 29000 [8.5] | 22100 [6.5] | 6900 [2.0] | 14 | 11.5 | 975 [460.1] | 8050346 |
| | | RCF3624HTAM | 30000 [8.8] | 22900 [6.7] | 7100 [2.1] | 15.5 | 13 | 975 [460.1] | 8050354 |
| | | RCF3624MTAM | 30000 [8.8] | 22900 [6.7] | 7100 [2.1] | 14.5 | 12 | 1050 [495.5] | 8050365 |
| RA1330AJ1 | R802VA125524MSA | RCF3624HTAM | 30000 [8.8] | 22900 [6.7] | 7100 [2.1] | 15.5 | 13 | 1050 [495.5] | 7982328 |
| | | RCF3624MTAM | 30000 [8.8] | 22900 [6.7] | 7100 [2.1] | 15.1 | 12.5 | 1050 [495.5] | 7982333 |
| RA1330AJ1 | R802VA125524MXA | RCF3624HTAM | 30000 [8.8] | 22900 [6.7] | 7100 [2.1] | 15.5 | 13 | 1050 [495.5] | 8050355 |
| | | RCF3624MTAM | 30000 [8.8] | 22900 [6.7] | 7100 [2.1] | 15.1 | 12.5 | 1050 [495.5] | 8050366 |
| RA1330AJ1 | R802VA125524ZSA | RCF3624HTAM | 30000 [8.8] | 22900 [6.7] | 7100 [2.1] | 15.5 | 13 | 1075 [507.3] | 7982329 |
| | | RCF3624MTAM | 30000 [8.8] | 22900 [6.7] | 7100 [2.1] | 15 | 12.5 | 1000 [471.9] | 7982334 |
| RA1330AJ1 | R802VA125524ZXA | RCF3624HTAM | 30000 [8.8] | 22900 [6.7] | 7100 [2.1] | 15.5 | 13 | 1075 [507.3] | 8050356 |
| | | RCF3624MTAM | 30000 [8.8] | 22900 [6.7] | 7100 [2.1] | 15 | 12.5 | 1000 [471.9] | 8050367 |
| RA1336AC1 | R802VA050317MSA | RCF3617STAM | 34400 [10.1] | 24100 [7.1] | 10300 [3.0] | 13 | 11.5 | 975 [460.1] | 7982369 |
| | | RCF3621HTAM | 36000 [10.6] | 25400 [7.4] | 10600 [3.1] | 14.5 | 12 | 975 [460.1] | 8086547 |
| | | RCF3621MTAM | 36000 [10.6] | 25400 [7.4] | 10600 [3.1] | 14 | 11.5 | 975 [460.1] | 7982373 |
| | | RCF3621STAM | 34600 [10.1] | 24300 [7.1] | 10300 [3.0] | 13 | 11.5 | 975 [460.1] | 7982380 |

[] Designates Metric Conversions

Performance Data @ AHRI Standard Conditions – Cooling (con't.)

| R802V: Prestige 2-Stage 80% ECM Furnace Ratings | | | | | | | | | |
|---|-----------------|-------------|------------------------------|----------------------------|--------------------------|------|------|---------------------|---------|
| Outdoor Unit | Furnace | Indoor Coil | Total Capacity BTU/H [kW] | Net Sensible BTU/H [kW] | Net Latent BTU/H [kW] | SEER | EER | Indoor CFM [L/s] | AHRI# |
| RA1336AC1 | R802VA050317MXA | RCF3617STAM | 34400 [10.1] | 24100 [7.1] | 10300 [3.0] | 13 | 11.5 | 975 [460.1] | 8050442 |
| | | RCF3621MTAM | 36000 [10.6] | 25400 [7.4] | 10600 [3.1] | 14 | 11.5 | 975 [460.1] | 8050453 |
| | | RCF3621STAM | 34600 [10.1] | 24300 [7.1] | 10300 [3.0] | 13 | 11.5 | 975 [460.1] | 8050469 |
| RA1336AC1 | R802VA075317MSA | RCF3617STAM | 35600 [10.4] | 26000 [7.6] | 9600 [2.8] | 13.5 | 11.5 | 1150 [542.7] | 7982370 |
| | | RCF3621HTAM | 36000 [10.6] | 25400 [7.4] | 10600 [3.1] | 15 | 12.5 | 975 [460.1] | 8086548 |
| | | RCF3621MTAM | 36000 [10.6] | 25400 [7.4] | 10600 [3.1] | 14.5 | 12 | 1075 [507.3] | 7982374 |
| | | RCF3621STAM | 35600 [10.4] | 26000 [7.6] | 9600 [2.8] | 13.5 | 11.5 | 1150 [542.7] | 7982381 |
| RA1336AC1 | R802VA075317MXA | RCF3617STAM | 35600 [10.4] | 26000 [7.6] | 9600 [2.8] | 13.5 | 11.5 | 1150 [542.7] | 8050443 |
| | | RCF3621MTAM | 36000 [10.6] | 25400 [7.4] | 10600 [3.1] | 14.5 | 12 | 1075 [507.3] | 8050454 |
| | | RCF3621STAM | 35600 [10.4] | 26000 [7.6] | 9600 [2.8] | 13.5 | 11.5 | 1150 [542.7] | 8050470 |
| RA1336AC1 | R802VA075317ZSA | RCF3617STAM | 35000 [10.3] | 25000 [7.3] | 10000 [2.9] | 13.5 | 11.5 | 1050 [495.5] | 7982371 |
| | | RCF3621MTAM | 36000 [10.6] | 25400 [7.4] | 10600 [3.1] | 14.5 | 12 | 1000 [471.9] | 7982375 |
| | | RCF3621STAM | 35200 [10.3] | 25400 [7.4] | 9800 [2.9] | 13.5 | 11.5 | 1100 [519.1] | 7982382 |
| RA1336AC1 | R802VA075317ZXA | RCF3617STAM | 35000 [10.3] | 25000 [7.3] | 10000 [2.9] | 13.5 | 11.5 | 1050 [495.5] | 8050444 |
| | | RCF3621MTAM | 36000 [10.6] | 25400 [7.4] | 10600 [3.1] | 14.5 | 12 | 1000 [471.9] | 8050455 |
| | | RCF3621STAM | 35200 [10.3] | 25400 [7.4] | 9800 [2.9] | 13.5 | 11.5 | 1100 [519.1] | 8050471 |
| RA1336AC1 | R802VA075421MSA | RCF3621HTAM | 36000 [10.6] | 25400 [7.4] | 10600 [3.1] | 15.1 | 12.5 | 1000 [471.9] | 8086549 |
| | | RCF3621MTAM | 36000 [10.6] | 25400 [7.4] | 10600 [3.1] | 14.5 | 12 | 1250 [589.9] | 8049043 |
| | | RCF3621STAM | 35400 [10.4] | 25600 [7.5] | 9800 [2.9] | 14 | 11.5 | 1100 [519.1] | 8049047 |
| | | RCF3624HTAM | 36000 [10.6] | 25400 [7.4] | 10600 [3.1] | 15.1 | 12.5 | 1250 [589.9] | 8049051 |
| | | RCF3624MTAM | 36000 [10.6] | 25400 [7.4] | 10600 [3.1] | 14.5 | 12 | 1250 [589.9] | 8049053 |
| RA1336AC1 | R802VA075421MXA | RCF3621HTAM | 36000 [10.6] | 25400 [7.4] | 10600 [3.1] | 15.1 | 12.5 | 1000 [471.9] | 8086550 |
| | | RCF3621MTAM | 36000 [10.6] | 25400 [7.4] | 10600 [3.1] | 14.5 | 12 | 1250 [589.9] | 8050456 |
| | | RCF3621STAM | 35400 [10.4] | 25600 [7.5] | 9800 [2.9] | 14 | 11.5 | 1100 [519.1] | 8050472 |
| | | RCF3624HTAM | 36000 [10.6] | 25400 [7.4] | 10600 [3.1] | 15.1 | 12.5 | 1250 [589.9] | 8050485 |
| | | RCF3624MTAM | 36000 [10.6] | 25400 [7.4] | 10600 [3.1] | 14.5 | 12 | 1250 [589.9] | 8050498 |
| RA1336AC1 | R802VA075421ZSA | RCF3621MTAM | 36000 [10.6] | 25400 [7.4] | 10600 [3.1] | 14.5 | 12 | 1075 [507.3] | 7982376 |
| | | RCF3621STAM | 35800 [10.5] | 26400 [7.7] | 9400 [2.8] | 13.5 | 11.5 | 1200 [566.3] | 7982383 |
| | | RCF3624HTAM | 36000 [10.6] | 25400 [7.4] | 10600 [3.1] | 15 | 12.5 | 1075 [507.3] | 7982387 |
| | | RCF3624MTAM | 36000 [10.6] | 25400 [7.4] | 10600 [3.1] | 14.5 | 12 | 1075 [507.3] | 7982392 |
| RA1336AC1 | R802VA075421ZXA | RCF3621MTAM | 36000 [10.6] | 25400 [7.4] | 10600 [3.1] | 14.5 | 12 | 1075 [507.3] | 8050457 |
| | | RCF3621STAM | 35800 [10.5] | 26400 [7.7] | 9400 [2.8] | 13.5 | 11.5 | 1200 [566.3] | 8050473 |
| | | RCF3624HTAM | 36000 [10.6] | 25400 [7.4] | 10600 [3.1] | 15 | 12.5 | 1075 [507.3] | 8050486 |
| | | RCF3624MTAM | 36000 [10.6] | 25400 [7.4] | 10600 [3.1] | 14.5 | 12 | 1075 [507.3] | 8050499 |
| RA1336AC1 | R802VA100521MSA | RCF3621HTAM | 36000 [10.6] | 25400 [7.4] | 10600 [3.1] | 15.1 | 12.5 | 1250 [589.9] | 8086551 |
| | | RCF3621MTAM | 36000 [10.6] | 25400 [7.4] | 10600 [3.1] | 14.5 | 12 | 1250 [589.9] | 7982377 |
| | | RCF3621STAM | 36000 [10.6] | 25400 [7.4] | 10600 [3.1] | 14 | 11.5 | 1250 [589.9] | 7982384 |
| | | RCF3624HTAM | 36000 [10.6] | 25400 [7.4] | 10600 [3.1] | 15.1 | 12.5 | 1250 [589.9] | 7982388 |
| | | RCF3624MTAM | 36000 [10.6] | 25400 [7.4] | 10600 [3.1] | 14.5 | 12 | 1250 [589.9] | 7982393 |
| RA1336AC1 | R802VA100521MXA | RCF3621MTAM | 36000 [10.6] | 25400 [7.4] | 10600 [3.1] | 14.5 | 12 | 1250 [589.9] | 8050458 |
| | | RCF3621STAM | 36000 [10.6] | 25400 [7.4] | 10600 [3.1] | 14 | 11.5 | 1250 [589.9] | 8050474 |
| | | RCF3624HTAM | 36000 [10.6] | 25400 [7.4] | 10600 [3.1] | 15.1 | 12.5 | 1250 [589.9] | 8050487 |
| | | RCF3624MTAM | 36000 [10.6] | 25400 [7.4] | 10600 [3.1] | 14.5 | 12 | 1250 [589.9] | 8050500 |
| RA1336AC1 | R802VA100521ZSA | RCF3621MTAM | 36000 [10.6] | 25400 [7.4] | 10600 [3.1] | 14.5 | 12 | 1200 [566.3] | 7982378 |
| | | RCF3621STAM | 36000 [10.6] | 25400 [7.4] | 10600 [3.1] | 13.5 | 11.5 | 1250 [589.9] | 7982385 |
| | | RCF3624HTAM | 36000 [10.6] | 25400 [7.4] | 10600 [3.1] | 15 | 12.5 | 1250 [589.9] | 7982389 |
| | | RCF3624MTAM | 36000 [10.6] | 25400 [7.4] | 10600 [3.1] | 14.5 | 12 | 1200 [566.3] | 7982394 |

[] Designates Metric Conversions



Performance Data @ AHRI Standard Conditions – Cooling (con't.)

| R802V: Prestige 2-Stage 80% ECM Furnace Ratings | | | | | | | | | |
|---|-----------------|-------------|---------------------------|-------------------------|-----------------------|------|------|------------------|---------|
| Outdoor Unit | Furnace | Indoor Coil | Total Capacity BTU/H [kW] | Net Sensible BTU/H [kW] | Net Latent BTU/H [kW] | SEER | EER | Indoor CFM [L/s] | AHRI# |
| RA1336AC1 | R802VA100521ZXA | RCF3621MTAM | 36000 [10.6] | 25400 [7.4] | 10600 [3.1] | 14.5 | 12 | 1200 [566.3] | 8050459 |
| | | RCF3621STAM | 36000 [10.6] | 25400 [7.4] | 10600 [3.1] | 13.5 | 11.5 | 1250 [589.9] | 8050475 |
| | | RCF3624HTAM | 36000 [10.6] | 25400 [7.4] | 10600 [3.1] | 15 | 12.5 | 1250 [589.9] | 8050488 |
| | | RCF3624MTAM | 36000 [10.6] | 25400 [7.4] | 10600 [3.1] | 14.5 | 12 | 1200 [566.3] | 8050501 |
| RA1336AC1 | R802VA125524MSA | RCF3624HTAM | 36000 [10.6] | 25400 [7.4] | 10600 [3.1] | 15.5 | 13 | 1000 [471.9] | 7982390 |
| | | RCF3624MTAM | 36000 [10.6] | 25400 [7.4] | 10600 [3.1] | 15 | 12.5 | 1000 [471.9] | 7982395 |
| RA1336AC1 | R802VA125524MXA | RCF3624HTAM | 36000 [10.6] | 25400 [7.4] | 10600 [3.1] | 15.5 | 13 | 1000 [471.9] | 8050489 |
| | | RCF3624MTAM | 36000 [10.6] | 25400 [7.4] | 10600 [3.1] | 15 | 12.5 | 1000 [471.9] | 8050502 |
| RA1336AC1 | R802VA125524ZSA | RCF3624HTAM | 36000 [10.6] | 25400 [7.4] | 10600 [3.1] | 15.1 | 12.5 | 1250 [589.9] | 7982391 |
| | | RCF3624MTAM | 36000 [10.6] | 25400 [7.4] | 10600 [3.1] | 14.5 | 12 | 1250 [589.9] | 7982396 |
| RA1336AC1 | R802VA125524ZXA | RCF3624HTAM | 36000 [10.6] | 25400 [7.4] | 10600 [3.1] | 15.1 | 12.5 | 1250 [589.9] | 8050490 |
| | | RCF3624MTAM | 36000 [10.6] | 25400 [7.4] | 10600 [3.1] | 14.5 | 12 | 1250 [589.9] | 8050503 |
| RA1336AJ1 | R802VA050317MSA | RCF3617STAM | 34400 [10.1] | 24100 [7.1] | 10300 [3.0] | 13 | 11.5 | 975 [460.1] | 7982426 |
| | | RCF3621HTAM | 36000 [10.6] | 25400 [7.4] | 10600 [3.1] | 14.5 | 12 | 975 [460.1] | 8086575 |
| | | RCF3621MTAM | 36000 [10.6] | 25400 [7.4] | 10600 [3.1] | 14 | 11.5 | 975 [460.1] | 7982430 |
| | | RCF3621STAM | 34600 [10.1] | 24300 [7.1] | 10300 [3.0] | 13 | 11.5 | 975 [460.1] | 7982437 |
| RA1336AJ1 | R802VA050317MXA | RCF3617STAM | 34400 [10.1] | 24100 [7.1] | 10300 [3.0] | 13 | 11.5 | 975 [460.1] | 8050587 |
| | | RCF3621MTAM | 36000 [10.6] | 25400 [7.4] | 10600 [3.1] | 14 | 11.5 | 975 [460.1] | 8050598 |
| | | RCF3621STAM | 34600 [10.1] | 24300 [7.1] | 10300 [3.0] | 13 | 11.5 | 975 [460.1] | 8050615 |
| RA1336AJ1 | R802VA075317MSA | RCF3617STAM | 35600 [10.4] | 26000 [7.6] | 9600 [2.8] | 13.5 | 11.5 | 1150 [542.7] | 7982427 |
| | | RCF3621HTAM | 36000 [10.6] | 25400 [7.4] | 10600 [3.1] | 15 | 12.5 | 975 [460.1] | 8086576 |
| | | RCF3621MTAM | 36000 [10.6] | 25400 [7.4] | 10600 [3.1] | 14.5 | 12 | 1075 [507.3] | 7982431 |
| | | RCF3621STAM | 35600 [10.4] | 26000 [7.6] | 9600 [2.8] | 13.5 | 11.5 | 1150 [542.7] | 7982438 |
| RA1336AJ1 | R802VA075317MXA | RCF3617STAM | 35600 [10.4] | 26000 [7.6] | 9600 [2.8] | 13.5 | 11.5 | 1150 [542.7] | 8050588 |
| | | RCF3621MTAM | 36000 [10.6] | 25400 [7.4] | 10600 [3.1] | 14.5 | 12 | 1075 [507.3] | 8050599 |
| | | RCF3621STAM | 35600 [10.4] | 26000 [7.6] | 9600 [2.8] | 13.5 | 11.5 | 1150 [542.7] | 8050616 |
| RA1336AJ1 | R802VA075317ZSA | RCF3617STAM | 35000 [10.3] | 25000 [7.3] | 10000 [2.9] | 13.5 | 11.5 | 1050 [495.5] | 7982428 |
| | | RCF3621MTAM | 36000 [10.6] | 25400 [7.4] | 10600 [3.1] | 14.5 | 12 | 1000 [471.9] | 7982432 |
| | | RCF3621STAM | 35200 [10.3] | 25400 [7.4] | 9800 [2.9] | 13.5 | 11.5 | 1100 [519.1] | 7982439 |
| RA1336AJ1 | R802VA075317ZXA | RCF3617STAM | 35000 [10.3] | 25000 [7.3] | 10000 [2.9] | 13.5 | 11.5 | 1050 [495.5] | 8050589 |
| | | RCF3621MTAM | 36000 [10.6] | 25400 [7.4] | 10600 [3.1] | 14.5 | 12 | 1000 [471.9] | 8050600 |
| | | RCF3621STAM | 35200 [10.3] | 25400 [7.4] | 9800 [2.9] | 13.5 | 11.5 | 1100 [519.1] | 8050617 |
| RA1336AJ1 | R802VA075421MSA | RCF3621HTAM | 36000 [10.6] | 25400 [7.4] | 10600 [3.1] | 15.1 | 12.5 | 1000 [471.9] | 8086577 |
| | | RCF3621MTAM | 36000 [10.6] | 25400 [7.4] | 10600 [3.1] | 14.5 | 12 | 1250 [589.9] | 8049077 |
| | | RCF3621STAM | 35400 [10.4] | 25600 [7.5] | 9800 [2.9] | 14 | 11.5 | 1100 [519.1] | 8049081 |
| | | RCF3624HTAM | 36000 [10.6] | 25400 [7.4] | 10600 [3.1] | 15.1 | 12.5 | 1250 [589.9] | 8049085 |
| | | RCF3624MTAM | 36000 [10.6] | 25400 [7.4] | 10600 [3.1] | 14.5 | 12 | 1250 [589.9] | 8049087 |
| RA1336AJ1 | R802VA075421MXA | RCF3621HTAM | 36000 [10.6] | 25400 [7.4] | 10600 [3.1] | 15.1 | 12.5 | 1000 [471.9] | 8086578 |
| | | RCF3621MTAM | 36000 [10.6] | 25400 [7.4] | 10600 [3.1] | 14.5 | 12 | 1250 [589.9] | 8050601 |
| | | RCF3621STAM | 35400 [10.4] | 25600 [7.5] | 9800 [2.9] | 14 | 11.5 | 1100 [519.1] | 8050618 |
| | | RCF3624HTAM | 36000 [10.6] | 25400 [7.4] | 10600 [3.1] | 15.1 | 12.5 | 1250 [589.9] | 8050635 |
| | | RCF3624MTAM | 36000 [10.6] | 25400 [7.4] | 10600 [3.1] | 14.5 | 12 | 1250 [589.9] | 8050669 |
| RA1336AJ1 | R802VA075421ZSA | RCF3621MTAM | 36000 [10.6] | 25400 [7.4] | 10600 [3.1] | 14.5 | 12 | 1075 [507.3] | 7982433 |
| | | RCF3621STAM | 35800 [10.5] | 26400 [7.7] | 9400 [2.8] | 13.5 | 11.5 | 1200 [566.3] | 7982440 |
| | | RCF3624HTAM | 36000 [10.6] | 25400 [7.4] | 10600 [3.1] | 15 | 12.5 | 1075 [507.3] | 7982444 |
| | | RCF3624MTAM | 36000 [10.6] | 25400 [7.4] | 10600 [3.1] | 14.5 | 12 | 1075 [507.3] | 7982449 |

[] Designates Metric Conversions

Performance Data @ AHRI Standard Conditions – Cooling (con't.)

| R802V: Prestige 2-Stage 80% ECM Furnace Ratings | | | | | | | | | |
|---|-----------------|-------------|------------------------------|----------------------------|--------------------------|------|------|---------------------|---------|
| Outdoor Unit | Furnace | Indoor Coil | Total Capacity BTU/H [kW] | Net Sensible BTU/H [kW] | Net Latent BTU/H [kW] | SEER | EER | Indoor CFM [L/s] | AHRI# |
| RA1336AJ1 | R802VA075421ZXA | RCF3621MTAM | 36000 [10.6] | 25400 [7.4] | 10600 [3.1] | 14.5 | 12 | 1075 [507.3] | 8050602 |
| | | RCF3621STAM | 35800 [10.5] | 26400 [7.7] | 9400 [2.8] | 13.5 | 11.5 | 1200 [566.3] | 8050619 |
| | | RCF3624HTAM | 36000 [10.6] | 25400 [7.4] | 10600 [3.1] | 15 | 12.5 | 1075 [507.3] | 8050637 |
| | | RCF3624MTAM | 36000 [10.6] | 25400 [7.4] | 10600 [3.1] | 14.5 | 12 | 1075 [507.3] | 8050672 |
| RA1336AJ1 | R802VA100521MSA | RCF3621HTAM | 36000 [10.6] | 25400 [7.4] | 10600 [3.1] | 15.1 | 12.5 | 1250 [589.9] | 8086579 |
| | | RCF3621MTAM | 36000 [10.6] | 25400 [7.4] | 10600 [3.1] | 14.5 | 12 | 1250 [589.9] | 7982434 |
| | | RCF3621STAM | 36000 [10.6] | 25400 [7.4] | 10600 [3.1] | 14 | 11.5 | 1250 [589.9] | 7982441 |
| | | RCF3624HTAM | 36000 [10.6] | 25400 [7.4] | 10600 [3.1] | 15.1 | 12.5 | 1250 [589.9] | 7982445 |
| | | RCF3624MTAM | 36000 [10.6] | 25400 [7.4] | 10600 [3.1] | 14.5 | 12 | 1250 [589.9] | 7982450 |
| RA1336AJ1 | R802VA100521MXA | RCF3621MTAM | 36000 [10.6] | 25400 [7.4] | 10600 [3.1] | 14.5 | 12 | 1250 [589.9] | 8050603 |
| | | RCF3621STAM | 36000 [10.6] | 25400 [7.4] | 10600 [3.1] | 14 | 11.5 | 1250 [589.9] | 8050620 |
| | | RCF3624HTAM | 36000 [10.6] | 25400 [7.4] | 10600 [3.1] | 15.1 | 12.5 | 1250 [589.9] | 8050640 |
| | | RCF3624MTAM | 36000 [10.6] | 25400 [7.4] | 10600 [3.1] | 14.5 | 12 | 1250 [589.9] | 8050674 |
| RA1336AJ1 | R802VA100521ZSA | RCF3621MTAM | 36000 [10.6] | 25400 [7.4] | 10600 [3.1] | 14.5 | 12 | 1200 [566.3] | 7982435 |
| | | RCF3621STAM | 36000 [10.6] | 25400 [7.4] | 10600 [3.1] | 13.5 | 11.5 | 1250 [589.9] | 7982442 |
| | | RCF3624HTAM | 36000 [10.6] | 25400 [7.4] | 10600 [3.1] | 15 | 12.5 | 1250 [589.9] | 7982446 |
| | | RCF3624MTAM | 36000 [10.6] | 25400 [7.4] | 10600 [3.1] | 14.5 | 12 | 1200 [566.3] | 7982451 |
| RA1336AJ1 | R802VA100521ZXA | RCF3621MTAM | 36000 [10.6] | 25400 [7.4] | 10600 [3.1] | 14.5 | 12 | 1200 [566.3] | 8050604 |
| | | RCF3621STAM | 36000 [10.6] | 25400 [7.4] | 10600 [3.1] | 13.5 | 11.5 | 1250 [589.9] | 8050621 |
| | | RCF3624HTAM | 36000 [10.6] | 25400 [7.4] | 10600 [3.1] | 15 | 12.5 | 1250 [589.9] | 8050642 |
| | | RCF3624MTAM | 36000 [10.6] | 25400 [7.4] | 10600 [3.1] | 14.5 | 12 | 1200 [566.3] | 8050676 |
| RA1336AJ1 | R802VA125524MSA | RCF3624HTAM | 36000 [10.6] | 25400 [7.4] | 10600 [3.1] | 15.5 | 13 | 1000 [471.9] | 7982447 |
| | | RCF3624MTAM | 36000 [10.6] | 25400 [7.4] | 10600 [3.1] | 15 | 12.5 | 1000 [471.9] | 7982452 |
| RA1336AJ1 | R802VA125524MXA | RCF3624HTAM | 36000 [10.6] | 25400 [7.4] | 10600 [3.1] | 15.5 | 13 | 1000 [471.9] | 8050644 |
| | | RCF3624MTAM | 36000 [10.6] | 25400 [7.4] | 10600 [3.1] | 15 | 12.5 | 1000 [471.9] | 8050679 |
| RA1336AJ1 | R802VA125524ZSA | RCF3624HTAM | 36000 [10.6] | 25400 [7.4] | 10600 [3.1] | 15.1 | 12.5 | 1250 [589.9] | 7982448 |
| | | RCF3624MTAM | 36000 [10.6] | 25400 [7.4] | 10600 [3.1] | 14.5 | 12 | 1250 [589.9] | 7982453 |
| RA1336AJ1 | R802VA125524ZXA | RCF3624HTAM | 36000 [10.6] | 25400 [7.4] | 10600 [3.1] | 15.1 | 12.5 | 1250 [589.9] | 8050647 |
| | | RCF3624MTAM | 36000 [10.6] | 25400 [7.4] | 10600 [3.1] | 14.5 | 12 | 1250 [589.9] | 8050681 |
| RA1342AC1 | R802VA050317MSA | RCF4821MTAM | 40000 [11.7] | 26600 [7.8] | 13400 [3.9] | 13.5 | 11.5 | 1100 [519.1] | 8086605 |
| | | RCF4821STAM | 39000 [11.4] | 27200 [8.0] | 11800 [3.5] | 13 | 11.5 | 1100 [519.1] | 7982513 |
| RA1342AC1 | R802VA050317MXA | RCF4821STAM | 39000 [11.4] | 27200 [8.0] | 11800 [3.5] | 13 | 11.5 | 1100 [519.1] | 8050911 |
| RA1342AC1 | R802VA075317MSA | RCF4821MTAM | 40500 [11.9] | 27400 [8.0] | 13100 [3.8] | 14 | 11.5 | 1150 [542.7] | 8086606 |
| | | RCF4821STAM | 39500 [11.6] | 27900 [8.2] | 11600 [3.4] | 13.5 | 11.5 | 1150 [542.7] | 7982515 |
| RA1342AC1 | R802VA075317MXA | RCF4821STAM | 39500 [11.6] | 27900 [8.2] | 11600 [3.4] | 13.5 | 11.5 | 1150 [542.7] | 8050913 |
| RA1342AC1 | R802VA075317ZSA | RCF4821MTAM | 41000 [12.0] | 28800 [8.4] | 12200 [3.6] | 13.5 | 11.5 | 1325 [625.3] | 8086607 |
| | | RCF4821STAM | 39500 [11.6] | 28200 [8.3] | 11300 [3.3] | 13.5 | 11.5 | 1200 [566.3] | 7982517 |
| RA1342AC1 | R802VA075317ZXA | RCF4821STAM | 39500 [11.6] | 28200 [8.3] | 11300 [3.3] | 13.5 | 11.5 | 1200 [566.3] | 8050916 |
| RA1342AC1 | R802VA075421MSA | RCF4821MTAM | 42000 [12.3] | 30700 [9.0] | 11300 [3.3] | 14 | 11.5 | 1475 [696.1] | 8086608 |
| | | RCF4821STAM | 40000 [11.7] | 29000 [8.5] | 11000 [3.2] | 14 | 11.5 | 1250 [589.9] | 8049109 |
| | | RCF4824HTAM | 41500 [12.2] | 28600 [8.4] | 12900 [3.8] | 14.5 | 12 | 1250 [589.9] | 8049115 |
| | | RCF4824STAM | 40000 [11.7] | 29000 [8.5] | 11000 [3.2] | 14 | 11.5 | 1250 [589.9] | 8049120 |
| RA1342AC1 | R802VA075421MXA | RCF4821STAM | 40000 [11.7] | 29000 [8.5] | 11000 [3.2] | 14 | 11.5 | 1250 [589.9] | 8050919 |
| | | RCF4824HTAM | 41500 [12.2] | 28600 [8.4] | 12900 [3.8] | 14.5 | 12 | 1250 [589.9] | 8050949 |
| | | RCF4824STAM | 40000 [11.7] | 29000 [8.5] | 11000 [3.2] | 14 | 11.5 | 1250 [589.9] | 8050982 |
| RA1342AC1 | R802VA075421ZSA | RCF4821MTAM | 41000 [12.0] | 28400 [8.3] | 12600 [3.7] | 14 | 11.5 | 1250 [589.9] | 8086609 |
| | | RCF4821STAM | 40000 [11.7] | 29200 [8.6] | 10800 [3.2] | 13.5 | 11.5 | 1300 [613.5] | 7982519 |
| | | RCF4824HTAM | 42000 [12.3] | 29900 [8.8] | 12100 [3.5] | 14 | 11.5 | 1400 [660.7] | 7982525 |
| | | RCF4824STAM | 40000 [11.7] | 29200 [8.6] | 10800 [3.2] | 13.5 | 11.5 | 1300 [613.5] | 7982536 |

[] Designates Metric Conversions



Performance Data @ AHRI Standard Conditions – Cooling (con't.)

| R802V: Prestige 2-Stage 80% ECM Furnace Ratings | | | | | | | | | |
|---|-----------------|-------------|---------------------------|-------------------------|-----------------------|------|------|------------------|---------|
| Outdoor Unit | Furnace | Indoor Coil | Total Capacity BTU/H [kW] | Net Sensible BTU/H [kW] | Net Latent BTU/H [kW] | SEER | EER | Indoor CFM [L/s] | AHRI# |
| RA1342AC1 | R802VA075421ZXA | RCF4821STAM | 40000 [11.7] | 29200 [8.6] | 10800 [3.2] | 13.5 | 11.5 | 1300 [613.5] | 8050922 |
| | | RCF4824HTAM | 42000 [12.3] | 29900 [8.8] | 12100 [3.5] | 14 | 11.5 | 1400 [660.7] | 8050951 |
| | | RCF4824STAM | 40000 [11.7] | 29200 [8.6] | 10800 [3.2] | 13.5 | 11.5 | 1300 [613.5] | 8050985 |
| RA1342AC1 | R802VA100521MSA | RCF4821MTAM | 41000 [12.0] | 28400 [8.3] | 12600 [3.7] | 14.5 | 12 | 1250 [589.9] | 8086610 |
| | | RCF4821STAM | 41000 [12.0] | 30800 [9.0] | 10200 [3.0] | 14 | 11.5 | 1400 [660.7] | 7982521 |
| | | RCF4824HTAM | 42000 [12.3] | 31400 [9.2] | 10600 [3.1] | 14.5 | 12 | 1400 [660.7] | 7982527 |
| | | RCF4824STAM | 41000 [12.0] | 30800 [9.0] | 10200 [3.0] | 14 | 11.5 | 1400 [660.7] | 7982538 |
| RA1342AC1 | R802VA100521MXA | RCF4821STAM | 41000 [12.0] | 30800 [9.0] | 10200 [3.0] | 14 | 11.5 | 1400 [660.7] | 8050924 |
| | | RCF4824HTAM | 42000 [12.3] | 31400 [9.2] | 10600 [3.1] | 14.5 | 12 | 1400 [660.7] | 8050954 |
| | | RCF4824STAM | 41000 [12.0] | 30800 [9.0] | 10200 [3.0] | 14 | 11.5 | 1400 [660.7] | 8050987 |
| RA1342AC1 | R802VA100521ZSA | RCF4821MTAM | 41000 [12.0] | 28700 [8.4] | 12300 [3.6] | 14 | 11.5 | 1300 [613.5] | 8086611 |
| | | RCF4821STAM | 41000 [12.0] | 31100 [9.1] | 9900 [2.9] | 13.5 | 11.5 | 1450 [684.3] | 7982523 |
| | | RCF4824HTAM | 42000 [12.3] | 31400 [9.2] | 10600 [3.1] | 14 | 11.5 | 1450 [684.3] | 7982529 |
| | | RCF4824STAM | 41000 [12.0] | 31100 [9.1] | 9900 [2.9] | 13.5 | 11.5 | 1450 [684.3] | 7982540 |
| RA1342AC1 | R802VA100521ZXA | RCF4821STAM | 41000 [12.0] | 31100 [9.1] | 9900 [2.9] | 13.5 | 11.5 | 1450 [684.3] | 8050927 |
| | | RCF4824HTAM | 42000 [12.3] | 31400 [9.2] | 10600 [3.1] | 14 | 11.5 | 1450 [684.3] | 8050956 |
| | | RCF4824STAM | 41000 [12.0] | 31100 [9.1] | 9900 [2.9] | 13.5 | 11.5 | 1450 [684.3] | 8050990 |
| RA1342AC1 | R802VA125524MSA | RCF4824HTAM | 42000 [12.3] | 31400 [9.2] | 10600 [3.1] | 14.5 | 12 | 1425 [672.5] | 7982531 |
| | | RCF4824STAM | 41000 [12.0] | 30800 [9.0] | 10200 [3.0] | 14 | 11.5 | 1425 [672.5] | 7982542 |
| RA1342AC1 | R802VA125524MXA | RCF4824HTAM | 42000 [12.3] | 31400 [9.2] | 10600 [3.1] | 14.5 | 12 | 1425 [672.5] | 8050959 |
| | | RCF4824STAM | 41000 [12.0] | 30800 [9.0] | 10200 [3.0] | 14 | 11.5 | 1425 [672.5] | 8050992 |
| RA1342AC1 | R802VA125524ZSA | RCF4824HTAM | 41500 [12.2] | 28300 [8.3] | 13200 [3.9] | 14.5 | 12 | 1200 [566.3] | 7982533 |
| | | RCF4824STAM | 40000 [11.7] | 28700 [8.4] | 11300 [3.3] | 14 | 11.5 | 1200 [566.3] | 7982544 |
| RA1342AC1 | R802VA125524ZXA | RCF4824HTAM | 41500 [12.2] | 28300 [8.3] | 13200 [3.9] | 14.5 | 12 | 1200 [566.3] | 8050961 |
| | | RCF4824STAM | 40000 [11.7] | 28700 [8.4] | 11300 [3.3] | 14 | 11.5 | 1200 [566.3] | 8050995 |
| RA1342AJ1 | R802VA050317MSA | RCF4821MTAM | 40000 [11.7] | 26600 [7.8] | 13400 [3.9] | 13.5 | 11.5 | 1100 [519.1] | 8086661 |
| | | RCF4821STAM | 39000 [11.4] | 27200 [8.0] | 11800 [3.5] | 13 | 11.5 | 1100 [519.1] | 7982579 |
| RA1342AJ1 | R802VA050317MXA | RCF4821STAM | 39000 [11.4] | 27200 [8.0] | 11800 [3.5] | 13 | 11.5 | 1100 [519.1] | 8051129 |
| RA1342AJ1 | R802VA075317MSA | RCF4821MTAM | 40500 [11.9] | 27400 [8.0] | 13100 [3.8] | 14 | 11.5 | 1150 [542.7] | 8086662 |
| | | RCF4821STAM | 39500 [11.6] | 27900 [8.2] | 11600 [3.4] | 13.5 | 11.5 | 1150 [542.7] | 7982582 |
| RA1342AJ1 | R802VA075317MXA | RCF4821STAM | 39500 [11.6] | 27900 [8.2] | 11600 [3.4] | 13.5 | 11.5 | 1150 [542.7] | 8051132 |
| RA1342AJ1 | R802VA075317ZSA | RCF4821MTAM | 41000 [12.0] | 28800 [8.4] | 12200 [3.6] | 13.5 | 11.5 | 1325 [625.3] | 8086663 |
| | | RCF4821STAM | 39500 [11.6] | 28200 [8.3] | 11300 [3.3] | 13.5 | 11.5 | 1200 [566.3] | 7982584 |
| RA1342AJ1 | R802VA075317ZXA | RCF4821STAM | 39500 [11.6] | 28200 [8.3] | 11300 [3.3] | 13.5 | 11.5 | 1200 [566.3] | 8051134 |
| RA1342AJ1 | R802VA075421MSA | RCF4821MTAM | 42000 [12.3] | 30700 [9.0] | 11300 [3.3] | 14 | 11.5 | 1475 [696.1] | 8086664 |
| | | RCF4821STAM | 40000 [11.7] | 29000 [8.5] | 11000 [3.2] | 14 | 11.5 | 1250 [589.9] | 8049141 |
| | | RCF4824HTAM | 41500 [12.2] | 28600 [8.4] | 12900 [3.8] | 14.5 | 12 | 1250 [589.9] | 8049147 |
| | | RCF4824STAM | 40000 [11.7] | 29000 [8.5] | 11000 [3.2] | 14 | 11.5 | 1250 [589.9] | 8049152 |
| RA1342AJ1 | R802VA075421MXA | RCF4821STAM | 40000 [11.7] | 29000 [8.5] | 11000 [3.2] | 14 | 11.5 | 1250 [589.9] | 8051137 |
| | | RCF4824HTAM | 41500 [12.2] | 28600 [8.4] | 12900 [3.8] | 14.5 | 12 | 1250 [589.9] | 8051167 |
| | | RCF4824STAM | 40000 [11.7] | 29000 [8.5] | 11000 [3.2] | 14 | 11.5 | 1250 [589.9] | 8051200 |
| RA1342AJ1 | R802VA075421ZSA | RCF4821MTAM | 41000 [12.0] | 28400 [8.3] | 12600 [3.7] | 14 | 11.5 | 1250 [589.9] | 8086665 |
| | | RCF4821STAM | 40000 [11.7] | 29200 [8.6] | 10800 [3.2] | 13.5 | 11.5 | 1300 [613.5] | 7982585 |
| | | RCF4824HTAM | 42000 [12.3] | 29900 [8.8] | 12100 [3.5] | 14 | 11.5 | 1400 [660.7] | 7982591 |
| | | RCF4824STAM | 40000 [11.7] | 29200 [8.6] | 10800 [3.2] | 13.5 | 11.5 | 1300 [613.5] | 7982602 |
| RA1342AJ1 | R802VA075421ZXA | RCF4821STAM | 40000 [11.7] | 29200 [8.6] | 10800 [3.2] | 13.5 | 11.5 | 1300 [613.5] | 8051140 |
| | | RCF4824HTAM | 42000 [12.3] | 29900 [8.8] | 12100 [3.5] | 14 | 11.5 | 1400 [660.7] | 8051169 |
| | | RCF4824STAM | 40000 [11.7] | 29200 [8.6] | 10800 [3.2] | 13.5 | 11.5 | 1300 [613.5] | 8051203 |

[] Designates Metric Conversions

Performance Data @ AHRI Standard Conditions – Cooling (con't.)

| R802V: Prestige 2-Stage 80% ECM Furnace Ratings | | | | | | | | | |
|---|-----------------|-------------|------------------------------|----------------------------|--------------------------|-------------|-------------|---------------------|---------|
| Outdoor Unit | Furnace | Indoor Coil | Total Capacity BTU/H [kW] | Net Sensible BTU/H [kW] | Net Latent BTU/H [kW] | SEER | EER | Indoor CFM [L/s] | AHRI# |
| RA1342AJ1 | R802VA100521MSA | RCF4821MTAM | 41000 [12.0] | 28400 [8.3] | 12600 [3.7] | 14.5 | 12 | 1250 [589.9] | 8086666 |
| | | RCF4821STAM | 41000 [12.0] | 30800 [9.0] | 10200 [3.0] | 14 | 11.5 | 1400 [660.7] | 7982587 |
| | | RCF4824HTAM | 42000 [12.3] | 31400 [9.2] | 10600 [3.1] | 14.5 | 12 | 1400 [660.7] | 7982593 |
| | | RCF4824STAM | 41000 [12.0] | 30800 [9.0] | 10200 [3.0] | 14 | 11.5 | 1400 [660.7] | 7982604 |
| RA1342AJ1 | R802VA100521MXA | RCF4821STAM | 41000 [12.0] | 30800 [9.0] | 10200 [3.0] | 14 | 11.5 | 1400 [660.7] | 8051142 |
| | | RCF4824HTAM | 42000 [12.3] | 31400 [9.2] | 10600 [3.1] | 14.5 | 12 | 1400 [660.7] | 8051171 |
| | | RCF4824STAM | 41000 [12.0] | 30800 [9.0] | 10200 [3.0] | 14 | 11.5 | 1400 [660.7] | 8051205 |
| RA1342AJ1 | R802VA100521ZSA | RCF4821MTAM | 41000 [12.0] | 28700 [8.4] | 12300 [3.6] | 14 | 11.5 | 1300 [613.5] | 8086667 |
| | | RCF4821STAM | 41000 [12.0] | 31100 [9.1] | 9900 [2.9] | 13.5 | 11.5 | 1450 [684.3] | 7982589 |
| | | RCF4824HTAM | 42000 [12.3] | 31400 [9.2] | 10600 [3.1] | 14 | 11.5 | 1450 [684.3] | 7982595 |
| | | RCF4824STAM | 41000 [12.0] | 31100 [9.1] | 9900 [2.9] | 13.5 | 11.5 | 1450 [684.3] | 7982606 |
| RA1342AJ1 | R802VA100521ZXA | RCF4821STAM | 41000 [12.0] | 31100 [9.1] | 9900 [2.9] | 13.5 | 11.5 | 1450 [684.3] | 8051145 |
| | | RCF4824HTAM | 42000 [12.3] | 31400 [9.2] | 10600 [3.1] | 14 | 11.5 | 1450 [684.3] | 8051174 |
| | | RCF4824STAM | 41000 [12.0] | 31100 [9.1] | 9900 [2.9] | 13.5 | 11.5 | 1450 [684.3] | 8051207 |
| RA1342AJ1 | R802VA125524MSA | RCF4824HTAM | 42000 [12.3] | 31400 [9.2] | 10600 [3.1] | 14.5 | 12 | 1425 [672.5] | 7982597 |
| | | RCF4824STAM | 41000 [12.0] | 30800 [9.0] | 10200 [3.0] | 14 | 11.5 | 1425 [672.5] | 7982608 |
| RA1342AJ1 | R802VA125524MXA | RCF4824HTAM | 42000 [12.3] | 31400 [9.2] | 10600 [3.1] | 14.5 | 12 | 1425 [672.5] | 8051176 |
| | | RCF4824STAM | 41000 [12.0] | 30800 [9.0] | 10200 [3.0] | 14 | 11.5 | 1425 [672.5] | 8051210 |
| RA1342AJ1 | R802VA125524ZSA | RCF4824HTAM | 41500 [12.2] | 28300 [8.3] | 13200 [3.9] | 14.5 | 12 | 1200 [566.3] | 7982599 |
| | | RCF4824STAM | 40000 [11.7] | 28700 [8.4] | 11300 [3.3] | 14 | 11.5 | 1200 [566.3] | 7982610 |
| RA1342AJ1 | R802VA125524ZXA | RCF4824HTAM | 41500 [12.2] | 28300 [8.3] | 13200 [3.9] | 14.5 | 12 | 1200 [566.3] | 8051179 |
| | | RCF4824STAM | 40000 [11.7] | 28700 [8.4] | 11300 [3.3] | 14 | 11.5 | 1200 [566.3] | 8051212 |
| RA1348AC1 | R802VA075317ZSA | RCF4821MTAM | 47500 [13.9] | 31300 [9.2] | 16200 [4.7] | 13 | 11.5 | 1325 [625.3] | 8086717 |
| RA1348AC1 | R802VA075421MSA | RCF4821MTAM | 48000 [14.1] | 34400 [10.1] | 13600 [4.0] | 13.5 | 11.5 | 1550 [731.5] | 8086718 |
| | | RCF4821STAM | 46500 [13.6] | 31600 [9.3] | 14900 [4.4] | 13.5 | 11.5 | 1250 [589.9] | 8049174 |
| | | RCF4824HTAM | 48000 [14.1] | 34400 [10.1] | 13600 [4.0] | 14 | 11.5 | 1350 [637.1] | 8049179 |
| | | RCF4824STAM | 46500 [13.6] | 31600 [9.3] | 14900 [4.4] | 13.5 | 11.5 | 1250 [589.9] | 8049184 |
| RA1348AC1 | R802VA075421MXA | RCF4821STAM | 46500 [13.6] | 31600 [9.3] | 14900 [4.4] | 13.5 | 11.5 | 1250 [589.9] | 8051347 |
| | | RCF4824HTAM | 48000 [14.1] | 34400 [10.1] | 13600 [4.0] | 14 | 11.5 | 1350 [637.1] | 8051375 |
| | | RCF4824STAM | 46500 [13.6] | 31600 [9.3] | 14900 [4.4] | 13.5 | 11.5 | 1250 [589.9] | 8051405 |
| | | RA1348AC1 | R802VA075421ZSA | RCF4821MTAM | 47500 [13.9] | 31200 [9.1] | 16300 [4.8] | 13.5 | 11.5 |
| RCF4821STAM | 47000 [13.8] | | | 33000 [9.7] | 14000 [4.1] | 13 | 11.5 | 1400 [660.7] | 7982646 |
| RCF4824HTAM | 48000 [14.1] | | | 34400 [10.1] | 13600 [4.0] | 13.5 | 11.5 | 1450 [684.3] | 7982652 |
| RCF4824STAM | 47000 [13.8] | | | 33000 [9.7] | 14000 [4.1] | 13 | 11.5 | 1400 [660.7] | 7982663 |
| RA1348AC1 | R802VA075421ZXA | RCF4821STAM | 47000 [13.8] | 33000 [9.7] | 14000 [4.1] | 13 | 11.5 | 1400 [660.7] | 8051349 |
| | | RCF4824HTAM | 48000 [14.1] | 34400 [10.1] | 13600 [4.0] | 13.5 | 11.5 | 1450 [684.3] | 8051377 |
| | | RCF4824STAM | 47000 [13.8] | 33000 [9.7] | 14000 [4.1] | 13 | 11.5 | 1400 [660.7] | 8051407 |
| RA1348AC1 | R802VA100521MSA | RCF4821MTAM | 48000 [14.1] | 34400 [10.1] | 13600 [4.0] | 14 | 11.5 | 1400 [660.7] | 8086720 |
| | | RCF4821STAM | 47500 [13.9] | 33500 [9.8] | 14000 [4.1] | 13.5 | 11.5 | 1400 [660.7] | 7982648 |
| | | RCF4824HTAM | 48000 [14.1] | 34400 [10.1] | 13600 [4.0] | 14 | 11.5 | 1525 [719.7] | 7982654 |
| | | RCF4824STAM | 47500 [13.9] | 33500 [9.8] | 14000 [4.1] | 13.5 | 11.5 | 1400 [660.7] | 7982665 |
| RA1348AC1 | R802VA100521MXA | RCF4821STAM | 47500 [13.9] | 33500 [9.8] | 14000 [4.1] | 13.5 | 11.5 | 1400 [660.7] | 8051351 |
| | | RCF4824HTAM | 48000 [14.1] | 34400 [10.1] | 13600 [4.0] | 14 | 11.5 | 1525 [719.7] | 8051379 |
| | | RCF4824STAM | 47500 [13.9] | 33500 [9.8] | 14000 [4.1] | 13.5 | 11.5 | 1400 [660.7] | 8051409 |
| RA1348AC1 | R802VA100521ZSA | RCF4821MTAM | 48000 [14.1] | 34400 [10.1] | 13600 [4.0] | 13.5 | 11.5 | 1500 [707.9] | 8086721 |
| | | RCF4821STAM | 47500 [13.9] | 34500 [10.1] | 13000 [3.8] | 13 | 11.5 | 1550 [731.5] | 7982650 |
| | | RCF4824HTAM | 48000 [14.1] | 34400 [10.1] | 13600 [4.0] | 13.5 | 11.5 | 1600 [755.1] | 7982657 |
| | | RCF4824STAM | 47500 [13.9] | 34500 [10.1] | 13000 [3.8] | 13 | 11.5 | 1550 [731.5] | 7982667 |

[] Designates Metric Conversions



Performance Data @ AHRI Standard Conditions – Cooling (con't.)

| R802V: Prestige 2-Stage 80% ECM Furnace Ratings | | | | | | | | | |
|---|-----------------|-------------|---------------------------|-------------------------|-----------------------|------|------|------------------|---------|
| Outdoor Unit | Furnace | Indoor Coil | Total Capacity BTU/H [kW] | Net Sensible BTU/H [kW] | Net Latent BTU/H [kW] | SEER | EER | Indoor CFM [L/s] | AHRI# |
| RA1348AC1 | R802VA100521ZXA | RCF4821STAM | 47500 [13.9] | 34500 [10.1] | 13000 [3.8] | 13 | 11.5 | 1550 [731.5] | 8051354 |
| | | RCF4824HTAM | 48000 [14.1] | 34400 [10.1] | 13600 [4.0] | 13.5 | 11.5 | 1600 [755.1] | 8051381 |
| | | RCF4824STAM | 47500 [13.9] | 34500 [10.1] | 13000 [3.8] | 13 | 11.5 | 1550 [731.5] | 8051412 |
| RA1348AC1 | R802VA125524MSA | RCF4824HTAM | 48000 [14.1] | 34400 [10.1] | 13600 [4.0] | 14 | 11.5 | 1575 [743.3] | 7982659 |
| | | RCF4824STAM | 48000 [14.1] | 34800 [10.2] | 13200 [3.9] | 13.5 | 11.5 | 1525 [719.7] | 7982670 |
| RA1348AC1 | R802VA125524MXA | RCF4824HTAM | 48000 [14.1] | 34400 [10.1] | 13600 [4.0] | 14 | 11.5 | 1575 [743.3] | 8051383 |
| | | RCF4824STAM | 48000 [14.1] | 34800 [10.2] | 13200 [3.9] | 13.5 | 11.5 | 1525 [719.7] | 8051414 |
| RA1348AC1 | R802VA125524ZSA | RCF4824HTAM | 48000 [14.1] | 34400 [10.1] | 13600 [4.0] | 14 | 11.5 | 1325 [625.3] | 7982661 |
| | | RCF4824STAM | 46500 [13.6] | 31600 [9.3] | 14900 [4.4] | 13.5 | 11.5 | 1250 [589.9] | 7982672 |
| RA1348AC1 | R802VA125524ZXA | RCF4824HTAM | 48000 [14.1] | 34400 [10.1] | 13600 [4.0] | 14 | 11.5 | 1325 [625.3] | 8051386 |
| | | RCF4824STAM | 46500 [13.6] | 31600 [9.3] | 14900 [4.4] | 13.5 | 11.5 | 1250 [589.9] | 8051416 |
| RA1348AJ1 | R802VA075317ZSA | RCF4821MTAM | 47500 [13.9] | 31300 [9.2] | 16200 [4.7] | 13 | 11.5 | 1325 [625.3] | 8086753 |
| RA1348AJ1 | R802VA075421MSA | RCF4821MTAM | 48000 [14.1] | 34400 [10.1] | 13600 [4.0] | 13.5 | 11.5 | 1550 [731.5] | 8086754 |
| | | RCF4821STAM | 46500 [13.6] | 31600 [9.3] | 14900 [4.4] | 13.5 | 11.5 | 1250 [589.9] | 8049209 |
| | | RCF4824HTAM | 48000 [14.1] | 34400 [10.1] | 13600 [4.0] | 14 | 11.5 | 1350 [637.1] | 8049214 |
| | | RCF4824STAM | 46500 [13.6] | 31600 [9.3] | 14900 [4.4] | 13.5 | 11.5 | 1250 [589.9] | 8049219 |
| RA1348AJ1 | R802VA075421MXA | RCF4821STAM | 46500 [13.6] | 31600 [9.3] | 14900 [4.4] | 13.5 | 11.5 | 1250 [589.9] | 8051528 |
| | | RCF4824HTAM | 48000 [14.1] | 34400 [10.1] | 13600 [4.0] | 14 | 11.5 | 1350 [637.1] | 8051556 |
| | | RCF4824STAM | 46500 [13.6] | 31600 [9.3] | 14900 [4.4] | 13.5 | 11.5 | 1250 [589.9] | 8051570 |
| RA1348AJ1 | R802VA075421ZSA | RCF4821MTAM | 47500 [13.9] | 31200 [9.1] | 16300 [4.8] | 13.5 | 11.5 | 1300 [613.5] | 8086755 |
| | | RCF4821STAM | 47000 [13.8] | 33000 [9.7] | 14000 [4.1] | 13 | 11.5 | 1400 [660.7] | 7982703 |
| | | RCF4824HTAM | 48000 [14.1] | 34400 [10.1] | 13600 [4.0] | 13.5 | 11.5 | 1450 [684.3] | 7982712 |
| | | RCF4824STAM | 47000 [13.8] | 33000 [9.7] | 14000 [4.1] | 13 | 11.5 | 1400 [660.7] | 7982724 |
| RA1348AJ1 | R802VA075421ZXA | RCF4821STAM | 47000 [13.8] | 33000 [9.7] | 14000 [4.1] | 13 | 11.5 | 1400 [660.7] | 8051530 |
| | | RCF4824HTAM | 48000 [14.1] | 34400 [10.1] | 13600 [4.0] | 13.5 | 11.5 | 1450 [684.3] | 8051559 |
| | | RCF4824STAM | 47000 [13.8] | 33000 [9.7] | 14000 [4.1] | 13 | 11.5 | 1400 [660.7] | 8051571 |
| RA1348AJ1 | R802VA100521MSA | RCF4821MTAM | 48000 [14.1] | 34400 [10.1] | 13600 [4.0] | 14 | 11.5 | 1400 [660.7] | 8086756 |
| | | RCF4821STAM | 47500 [13.9] | 33500 [9.8] | 14000 [4.1] | 13.5 | 11.5 | 1400 [660.7] | 7982706 |
| | | RCF4824HTAM | 48000 [14.1] | 34400 [10.1] | 13600 [4.0] | 14 | 11.5 | 1525 [719.7] | 7982714 |
| | | RCF4824STAM | 47500 [13.9] | 33500 [9.8] | 14000 [4.1] | 13.5 | 11.5 | 1400 [660.7] | 7982727 |
| RA1348AJ1 | R802VA100521MXA | RCF4821STAM | 47500 [13.9] | 33500 [9.8] | 14000 [4.1] | 13.5 | 11.5 | 1400 [660.7] | 8051533 |
| | | RCF4824HTAM | 48000 [14.1] | 34400 [10.1] | 13600 [4.0] | 14 | 11.5 | 1525 [719.7] | 8051560 |
| | | RCF4824STAM | 47500 [13.9] | 33500 [9.8] | 14000 [4.1] | 13.5 | 11.5 | 1400 [660.7] | 8051572 |
| RA1348AJ1 | R802VA100521ZSA | RCF4821MTAM | 48000 [14.1] | 34400 [10.1] | 13600 [4.0] | 13.5 | 11.5 | 1500 [707.9] | 8086757 |
| | | RCF4821STAM | 47500 [13.9] | 34500 [10.1] | 13000 [3.8] | 13 | 11.5 | 1550 [731.5] | 7982709 |
| | | RCF4824HTAM | 48000 [14.1] | 34400 [10.1] | 13600 [4.0] | 13.5 | 11.5 | 1600 [755.1] | 7982716 |
| | | RCF4824STAM | 47500 [13.9] | 34500 [10.1] | 13000 [3.8] | 13 | 11.5 | 1550 [731.5] | 7982730 |
| RA1348AJ1 | R802VA100521ZXA | RCF4821STAM | 47500 [13.9] | 34500 [10.1] | 13000 [3.8] | 13 | 11.5 | 1550 [731.5] | 8051535 |
| | | RCF4824HTAM | 48000 [14.1] | 34400 [10.1] | 13600 [4.0] | 13.5 | 11.5 | 1600 [755.1] | 8051561 |
| | | RCF4824STAM | 47500 [13.9] | 34500 [10.1] | 13000 [3.8] | 13 | 11.5 | 1550 [731.5] | 8051573 |
| RA1348AJ1 | R802VA125524MSA | RCF4824HTAM | 48000 [14.1] | 34400 [10.1] | 13600 [4.0] | 14 | 11.5 | 1575 [743.3] | 7982718 |
| | | RCF4824STAM | 48000 [14.1] | 34800 [10.2] | 13200 [3.9] | 13.5 | 11.5 | 1525 [719.7] | 7982733 |
| RA1348AJ1 | R802VA125524MXA | RCF4824HTAM | 48000 [14.1] | 34400 [10.1] | 13600 [4.0] | 14 | 11.5 | 1575 [743.3] | 8051562 |
| | | RCF4824STAM | 48000 [14.1] | 34800 [10.2] | 13200 [3.9] | 13.5 | 11.5 | 1525 [719.7] | 8051574 |
| RA1348AJ1 | R802VA125524ZSA | RCF4824HTAM | 48000 [14.1] | 34400 [10.1] | 13600 [4.0] | 14 | 11.5 | 1325 [625.3] | 7982721 |
| | | RCF4824STAM | 46500 [13.6] | 31600 [9.3] | 14900 [4.4] | 13.5 | 11.5 | 1250 [589.9] | 7982735 |
| RA1348AJ1 | R802VA125524ZXA | RCF4824HTAM | 48000 [14.1] | 34400 [10.1] | 13600 [4.0] | 14 | 11.5 | 1325 [625.3] | 8051563 |
| | | RCF4824STAM | 46500 [13.6] | 31600 [9.3] | 14900 [4.4] | 13.5 | 11.5 | 1250 [589.9] | 8051575 |

[] Designates Metric Conversions

Performance Data @ AHRI Standard Conditions – Cooling (con't.)

| R802V: Prestige 2-Stage 80% ECM Furnace Ratings | | | | | | | | | |
|---|-----------------|-------------|------------------------------|----------------------------|--------------------------|------|------|---------------------|---------|
| Outdoor Unit | Furnace | Indoor Coil | Total Capacity BTU/H [kW] | Net Sensible BTU/H [kW] | Net Latent BTU/H [kW] | SEER | EER | Indoor CFM [L/s] | AHRI# |
| RA1360AC1 | R802VA075421MSA | RCF6021STAM | 55500 [16.3] | 37700 [11.0] | 17800 [5.2] | 13 | 11 | 1600 [755.1] | 8086787 |
| | | RCF6024HTAM | 56500 [16.6] | 39800 [11.7] | 16700 [4.9] | 13.5 | 11.5 | 1550 [731.5] | 8049245 |
| | | RCF6024STAM | 56500 [16.6] | 39800 [11.7] | 16700 [4.9] | 13.5 | 11.5 | 1550 [731.5] | 8049250 |
| RA1360AC1 | R802VA075421MXA | RCF6021STAM | 55500 [16.3] | 37700 [11.0] | 17800 [5.2] | 13 | 11 | 1600 [755.1] | 8086788 |
| | | RCF6024HTAM | 56500 [16.6] | 39800 [11.7] | 16700 [4.9] | 13.5 | 11.5 | 1550 [731.5] | 8051632 |
| | | RCF6024STAM | 56500 [16.6] | 39800 [11.7] | 16700 [4.9] | 13.5 | 11.5 | 1550 [731.5] | 8051652 |
| RA1360AC1 | R802VA075421ZSA | RCF6024HTAM | 56000 [16.4] | 39600 [11.6] | 16400 [4.8] | 13 | 11 | 1600 [755.1] | 7982767 |
| | | RCF6024STAM | 56000 [16.4] | 39600 [11.6] | 16400 [4.8] | 13 | 11 | 1600 [755.1] | 7982777 |
| RA1360AC1 | R802VA075421ZXA | RCF6024HTAM | 56000 [16.4] | 39600 [11.6] | 16400 [4.8] | 13 | 11 | 1600 [755.1] | 8051634 |
| | | RCF6024STAM | 56000 [16.4] | 39600 [11.6] | 16400 [4.8] | 13 | 11 | 1600 [755.1] | 8051653 |
| RA1360AC1 | R802VA100521MSA | RCF6021STAM | 54000 [15.8] | 35100 [10.3] | 18900 [5.5] | 13.5 | 11 | 1400 [660.7] | 8086789 |
| | | RCF6024HTAM | 57000 [16.7] | 40500 [11.9] | 16500 [4.8] | 13.5 | 11.5 | 1575 [743.3] | 7982769 |
| | | RCF6024STAM | 57000 [16.7] | 40500 [11.9] | 16500 [4.8] | 13.5 | 11.5 | 1575 [743.3] | 7982780 |
| RA1360AC1 | R802VA100521MXA | RCF6024HTAM | 57000 [16.7] | 40500 [11.9] | 16500 [4.8] | 13.5 | 11.5 | 1575 [743.3] | 8051637 |
| | | RCF6024STAM | 57000 [16.7] | 40500 [11.9] | 16500 [4.8] | 13.5 | 11.5 | 1575 [743.3] | 8051654 |
| RA1360AC1 | R802VA100521ZSA | RCF6024HTAM | 55500 [16.3] | 37700 [11.0] | 17800 [5.2] | 13.5 | 11.5 | 1400 [660.7] | 7982771 |
| | | RCF6024STAM | 55500 [16.3] | 37700 [11.0] | 17800 [5.2] | 13.5 | 11.5 | 1400 [660.7] | 7982782 |
| RA1360AC1 | R802VA100521ZXA | RCF6024HTAM | 55500 [16.3] | 37700 [11.0] | 17800 [5.2] | 13.5 | 11.5 | 1400 [660.7] | 8051639 |
| | | RCF6024STAM | 55500 [16.3] | 37700 [11.0] | 17800 [5.2] | 13.5 | 11.5 | 1400 [660.7] | 8051655 |
| RA1360AC1 | R802VA125524MSA | RCF6024HTAM | 57500 [16.9] | 42600 [12.5] | 14900 [4.4] | 13.5 | 11.5 | 1775 [837.7] | 7982773 |
| | | RCF6024STAM | 57500 [16.9] | 42600 [12.5] | 14900 [4.4] | 13.5 | 11.5 | 1775 [837.7] | 7982784 |
| RA1360AC1 | R802VA125524MXA | RCF6024HTAM | 57500 [16.9] | 42600 [12.5] | 14900 [4.4] | 13.5 | 11.5 | 1775 [837.7] | 8051641 |
| | | RCF6024STAM | 57500 [16.9] | 42600 [12.5] | 14900 [4.4] | 13.5 | 11.5 | 1775 [837.7] | 8051656 |
| RA1360AC1 | R802VA125524ZSA | RCF6024HTAM | 56000 [16.4] | 38900 [11.4] | 17100 [5.0] | 13.5 | 11.5 | 1500 [707.9] | 7982775 |
| | | RCF6024STAM | 56000 [16.4] | 38900 [11.4] | 17100 [5.0] | 13.5 | 11.5 | 1500 [707.9] | 7982786 |
| RA1360AC1 | R802VA125524ZXA | RCF6024HTAM | 56000 [16.4] | 38900 [11.4] | 17100 [5.0] | 13.5 | 11.5 | 1500 [707.9] | 8051643 |
| | | RCF6024STAM | 56000 [16.4] | 38900 [11.4] | 17100 [5.0] | 13.5 | 11.5 | 1500 [707.9] | 8051657 |
| RA1360AJ1 | R802VA075421MSA | RCF6021STAM | 55500 [16.3] | 37700 [11.0] | 17800 [5.2] | 13 | 11 | 1600 [755.1] | 8086805 |
| | | RCF6024HTAM | 56500 [16.6] | 39800 [11.7] | 16700 [4.9] | 13.5 | 11.5 | 1550 [731.5] | 8049276 |
| | | RCF6024STAM | 56500 [16.6] | 39800 [11.7] | 16700 [4.9] | 13.5 | 11.5 | 1550 [731.5] | 8049281 |
| RA1360AJ1 | R802VA075421MXA | RCF6021STAM | 55500 [16.3] | 37700 [11.0] | 17800 [5.2] | 13 | 11 | 1600 [755.1] | 8086806 |
| | | RCF6024HTAM | 56500 [16.6] | 39800 [11.7] | 16700 [4.9] | 13.5 | 11.5 | 1550 [731.5] | 8051694 |
| | | RCF6024STAM | 56500 [16.6] | 39800 [11.7] | 16700 [4.9] | 13.5 | 11.5 | 1550 [731.5] | 8051706 |
| RA1360AJ1 | R802VA075421ZSA | RCF6024HTAM | 56000 [16.4] | 39600 [11.6] | 16400 [4.8] | 13 | 11 | 1600 [755.1] | 7982813 |
| | | RCF6024STAM | 56000 [16.4] | 39600 [11.6] | 16400 [4.8] | 13 | 11 | 1600 [755.1] | 7982824 |
| RA1360AJ1 | R802VA075421ZXA | RCF6024HTAM | 56000 [16.4] | 39600 [11.6] | 16400 [4.8] | 13 | 11 | 1600 [755.1] | 8051695 |
| | | RCF6024STAM | 56000 [16.4] | 39600 [11.6] | 16400 [4.8] | 13 | 11 | 1600 [755.1] | 8051707 |
| RA1360AJ1 | R802VA100521MSA | RCF6021STAM | 54000 [15.8] | 35100 [10.3] | 18900 [5.5] | 13.5 | 11 | 1400 [660.7] | 8086807 |
| | | RCF6024HTAM | 57000 [16.7] | 40500 [11.9] | 16500 [4.8] | 13.5 | 11.5 | 1575 [743.3] | 7982815 |
| | | RCF6024STAM | 57000 [16.7] | 40500 [11.9] | 16500 [4.8] | 13.5 | 11.5 | 1575 [743.3] | 7982826 |
| RA1360AJ1 | R802VA100521MXA | RCF6024HTAM | 57000 [16.7] | 40500 [11.9] | 16500 [4.8] | 13.5 | 11.5 | 1575 [743.3] | 8051696 |
| | | RCF6024STAM | 57000 [16.7] | 40500 [11.9] | 16500 [4.8] | 13.5 | 11.5 | 1575 [743.3] | 8051708 |
| RA1360AJ1 | R802VA100521ZSA | RCF6024HTAM | 55500 [16.3] | 37700 [11.0] | 17800 [5.2] | 13.5 | 11.5 | 1400 [660.7] | 7982818 |
| | | RCF6024STAM | 55500 [16.3] | 37700 [11.0] | 17800 [5.2] | 13.5 | 11.5 | 1400 [660.7] | 7982828 |
| RA1360AJ1 | R802VA100521ZXA | RCF6024HTAM | 55500 [16.3] | 37700 [11.0] | 17800 [5.2] | 13.5 | 11.5 | 1400 [660.7] | 8051697 |
| | | RCF6024STAM | 55500 [16.3] | 37700 [11.0] | 17800 [5.2] | 13.5 | 11.5 | 1400 [660.7] | 8051709 |
| RA1360AJ1 | R802VA125524MSA | RCF6024HTAM | 57500 [16.9] | 42600 [12.5] | 14900 [4.4] | 13.5 | 11.5 | 1775 [837.7] | 7982820 |
| | | RCF6024STAM | 57500 [16.9] | 42600 [12.5] | 14900 [4.4] | 13.5 | 11.5 | 1775 [837.7] | 7982831 |

[] Designates Metric Conversions

Performance Data @ AHRI Standard Conditions – Cooling (con't.)

| R802V: Prestige 2-Stage 80% ECM Furnace Ratings | | | | | | | | | |
|---|-----------------|-------------|------------------------------|----------------------------|--------------------------|------|------|---------------------|---------|
| Outdoor Unit | Furnace | Indoor Coil | Total Capacity BTU/H [kW] | Net Sensible BTU/H [kW] | Net Latent BTU/H [kW] | SEER | EER | Indoor CFM [L/s] | AHRI# |
| RA1360AJ1 | R802VA125524MXA | RCF6024HTAM | 57500 [16.9] | 42600 [12.5] | 14900 [4.4] | 13.5 | 11.5 | 1775 [837.7] | 8051698 |
| | | RCF6024STAM | 57500 [16.9] | 42600 [12.5] | 14900 [4.4] | 13.5 | 11.5 | 1775 [837.7] | 8051710 |
| RA1360AJ1 | R802VA125524ZSA | RCF6024HTAM | 56000 [16.4] | 38900 [11.4] | 17100 [5.0] | 13.5 | 11.5 | 1500 [707.9] | 7982822 |
| | | RCF6024STAM | 56000 [16.4] | 38900 [11.4] | 17100 [5.0] | 13.5 | 11.5 | 1500 [707.9] | 7982833 |
| RA1360AJ1 | R802VA125524ZXA | RCF6024HTAM | 56000 [16.4] | 38900 [11.4] | 17100 [5.0] | 13.5 | 11.5 | 1500 [707.9] | 8051699 |
| | | RCF6024STAM | 56000 [16.4] | 38900 [11.4] | 17100 [5.0] | 13.5 | 11.5 | 1500 [707.9] | 8051711 |

[] Designates Metric Conversions

Performance Data @ AHRI Standard Conditions – Cooling (con't.)

| R95T: 95% AFUE single-stage Constant Torque Multiphase Gas Furnace Ratings | | | | | | | | | |
|--|-----------------|-------------|------------------------------|----------------------------|--------------------------|------|------|---------------------|---------|
| Outdoor Unit | Furnace | Indoor Coil | Total Capacity BTU/H [kW] | Net Sensible BTU/H [kW] | Net Latent BTU/H [kW] | SEER | EER | Indoor CFM [L/s] | AHRI# |
| RA1318AJ1 | R95TA0401317MSA | RCF2417HTAM | 18000 [5.3] | 12900 [3.8] | 5100 [1.5] | 14.5 | 12 | 650 [306.8] | 7507411 |
| | | RCF2417MTAM | 18000 [5.3] | 12900 [3.8] | 5100 [1.5] | 14.5 | 12 | 650 [306.8] | 7507426 |
| | | RCF2417STAM | 18000 [5.3] | 13600 [4.0] | 4400 [1.3] | 14.5 | 12 | 650 [306.8] | 7507442 |
| | | RCF2421MTAM | 18000 [5.3] | 12900 [3.8] | 5100 [1.5] | 14.5 | 12 | 650 [306.8] | 7507474 |
| | | RCF2421HTAM | 18000 [5.3] | 12900 [3.8] | 5100 [1.5] | 14.5 | 12 | 650 [306.8] | 7507455 |
| RA1324AJ1 | R95TA0401317MSA | RCF2417HTAM | 24000 [7.0] | 17300 [5.1] | 6700 [2.0] | 14 | 11.5 | 875 [413.0] | 7507615 |
| | | RCF2417MTAM | 24000 [7.0] | 17300 [5.1] | 6700 [2.0] | 14 | 11.5 | 875 [413.0] | 7507633 |
| | | RCF2417STAM | 24000 [7.0] | 18200 [5.3] | 5800 [1.7] | 14 | 11.5 | 850 [401.2] | 7507652 |
| | | RCF2421MTAM | 24000 [7.0] | 17300 [5.1] | 6700 [2.0] | 14 | 11.5 | 875 [413.0] | 7507693 |
| RA1324AJ1 | R95TA0601317MSA | RCF2417HTAM | 24000 [7.0] | 17300 [5.1] | 6700 [2.0] | 14 | 11.5 | 850 [401.2] | 7507616 |
| | | RCF2417MTAM | 24000 [7.0] | 17300 [5.1] | 6700 [2.0] | 14 | 11.5 | 850 [401.2] | 7507634 |
| | | RCF2417STAM | 23400 [6.9] | 17200 [5.0] | 6200 [1.8] | 14 | 11.5 | 700 [330.4] | 7507653 |
| | | RCF2421MTAM | 24000 [7.0] | 17300 [5.1] | 6700 [2.0] | 14 | 11.5 | 850 [401.2] | 7507694 |
| RA1324AJ1 | R95TA0701317MSA | RCF2417HTAM | 24000 [7.0] | 17300 [5.1] | 6700 [2.0] | 14 | 11.5 | 850 [401.2] | 7507617 |
| | | RCF2417MTAM | 24000 [7.0] | 17300 [5.1] | 6700 [2.0] | 14 | 11.5 | 850 [401.2] | 7507635 |
| | | RCF2417STAM | 24000 [7.0] | 18100 [5.3] | 5900 [1.7] | 13.5 | 11.5 | 825 [389.4] | 7507654 |
| | | RCF2421MTAM | 24000 [7.0] | 17300 [5.1] | 6700 [2.0] | 14 | 11.5 | 850 [401.2] | 7507695 |
| RA1324AJ1 | R95TA0401317MSA | RCF2421HTAM | 24000 [7.0] | 17300 [5.1] | 6700 [2.0] | 14 | 11.5 | 875 [413.0] | 7507668 |
| RA1324AJ1 | R95TA0601317MSA | RCF2421HTAM | 24000 [7.0] | 17300 [5.1] | 6700 [2.0] | 14 | 11.5 | 850 [401.2] | 7507669 |
| RA1324AJ1 | R95TA0701317MSA | RCF2421HTAM | 24000 [7.0] | 17300 [5.1] | 6700 [2.0] | 14 | 11.5 | 850 [401.2] | 7507670 |
| RA1330AJ1 | R95TA0401317MSA | RCF3617STAM | 28600 [8.4] | 21600 [6.3] | 7000 [2.1] | 14 | 11.5 | 925 [436.6] | 7507850 |
| | | RCF3621HTAM | 30000 [8.8] | 22900 [6.7] | 7100 [2.1] | 15.1 | 12.5 | 1000 [471.9] | 8086524 |
| | | RCF3621MTAM | 30000 [8.8] | 22500 [6.6] | 7500 [2.2] | 14.5 | 12 | 1100 [519.1] | 7507870 |
| | | RCF3621STAM | 28800 [8.4] | 21900 [6.4] | 6900 [2.0] | 14 | 11.5 | 950 [448.4] | 7507901 |
| RA1330AJ1 | R95TA0601317MSA | RCF3617STAM | 28800 [8.4] | 22100 [6.5] | 6700 [2.0] | 13.5 | 11.5 | 1025 [483.7] | 7507851 |
| | | RCF3621HTAM | 30000 [8.8] | 22900 [6.7] | 7100 [2.1] | 14.5 | 12 | 1075 [507.3] | 8086525 |
| | | RCF3621MTAM | 30000 [8.8] | 21700 [6.4] | 8300 [2.4] | 14.5 | 12 | 900 [424.8] | 7507871 |
| | | RCF3621STAM | 29000 [8.5] | 22400 [6.6] | 6600 [1.9] | 13.5 | 11.5 | 1050 [495.5] | 7507902 |
| RA1330AJ1 | R95TA0701317MSA | RCF3617STAM | 28400 [8.3] | 21400 [6.3] | 7000 [2.1] | 13.5 | 11.5 | 925 [436.6] | 7507852 |
| | | RCF3621HTAM | 30000 [8.8] | 22900 [6.7] | 7100 [2.1] | 14.5 | 12 | 975 [460.1] | 8086526 |
| | | RCF3621MTAM | 29800 [8.7] | 21400 [6.3] | 8400 [2.5] | 14.5 | 12 | 875 [413.0] | 7507872 |
| | | RCF3621STAM | 28400 [8.3] | 21400 [6.3] | 7000 [2.1] | 13.5 | 11.5 | 925 [436.6] | 7507903 |
| RA1336AC1 | R95TA0401317MSA | RCF3617STAM | 35000 [10.3] | 25000 [7.3] | 10000 [2.9] | 13.5 | 11.5 | 1050 [495.5] | 7508195 |
| | | RCF3621HTAM | 36000 [10.6] | 25400 [7.4] | 10600 [3.1] | 15 | 12.5 | 1000 [471.9] | 8086552 |
| | | RCF3621MTAM | 36000 [10.6] | 24900 [7.3] | 11100 [3.3] | 14 | 11.5 | 1175 [554.5] | 7508215 |
| | | RCF3621STAM | 35200 [10.3] | 25300 [7.4] | 9900 [2.9] | 13.5 | 11.5 | 1075 [507.3] | 7508246 |
| RA1336AC1 | R95TA0601317MSA | RCF3617STAM | 34800 [10.2] | 24500 [7.2] | 10300 [3.0] | 13 | 11.5 | 1000 [471.9] | 7508196 |
| | | RCF3621HTAM | 36000 [10.6] | 25400 [7.4] | 10600 [3.1] | 14 | 11.5 | 1075 [507.3] | 8086553 |
| | | RCF3621MTAM | 36000 [10.6] | 24300 [7.1] | 11700 [3.4] | 14 | 11.5 | 1050 [495.5] | 7508216 |
| | | RCF3621STAM | 34800 [10.2] | 24700 [7.2] | 10100 [3.0] | 13 | 11.5 | 1025 [483.7] | 7508247 |
| RA1336AC1 | R95TA0701317MSA | RCF3617STAM | 34600 [10.1] | 24500 [7.2] | 10100 [3.0] | 13 | 11 | 1025 [483.7] | 7508197 |
| | | RCF3621HTAM | 36000 [10.6] | 25400 [7.4] | 10600 [3.1] | 14.5 | 12 | 975 [460.1] | 8086554 |
| | | RCF3621MTAM | 36000 [10.6] | 24500 [7.2] | 11500 [3.4] | 14 | 11.5 | 1075 [507.3] | 7508217 |
| | | RCF3621STAM | 34200 [10.0] | 23700 [6.9] | 10500 [3.1] | 13 | 11.5 | 925 [436.6] | 7508248 |
| RA1336AC1 | R95TA1151524MSA | RCF3624HTAM | 36000 [10.6] | 25600 [7.5] | 10400 [3.0] | 14 | 11.5 | 1325 [625.3] | 7508277 |
| | | RCF3624MTAM | 36000 [10.6] | 25400 [7.4] | 10600 [3.1] | 13.5 | 11.5 | 1275 [601.7] | 7508304 |

[] Designates Metric Conversions

Performance Data @ AHRI Standard Conditions – Cooling (con't.)

| R95T: 95% AFUE single-stage Constant Torque Multipoise Gas Furnace Ratings | | | | | | | | | |
|--|-----------------|-------------|---------------------------|-------------------------|-----------------------|------|------|------------------|---------|
| Outdoor Unit | Furnace | Indoor Coil | Total Capacity BTU/H [kW] | Net Sensible BTU/H [kW] | Net Latent BTU/H [kW] | SEER | EER | Indoor CFM [L/s] | AHRI# |
| RA1336AJ1 | R95TA0401317MSA | RCF3617STAM | 35000 [10.3] | 25000 [7.3] | 10000 [2.9] | 13.5 | 11.5 | 1050 [495.5] | 7508561 |
| | | RCF3621HTAM | 36000 [10.6] | 25400 [7.4] | 10600 [3.1] | 15 | 12.5 | 1000 [471.9] | 8086580 |
| | | RCF3621MTAM | 36000 [10.6] | 24900 [7.3] | 11100 [3.3] | 14 | 11.5 | 1175 [554.5] | 7508581 |
| | | RCF3621STAM | 35200 [10.3] | 25300 [7.4] | 9900 [2.9] | 13.5 | 11.5 | 1075 [507.3] | 7508612 |
| RA1336AJ1 | R95TA0601317MSA | RCF3617STAM | 34800 [10.2] | 24500 [7.2] | 10300 [3.0] | 13 | 11.5 | 1000 [471.9] | 7508562 |
| | | RCF3621HTAM | 36000 [10.6] | 25400 [7.4] | 10600 [3.1] | 14 | 11.5 | 1075 [507.3] | 8086581 |
| | | RCF3621MTAM | 36000 [10.6] | 24300 [7.1] | 11700 [3.4] | 14 | 11.5 | 1050 [495.5] | 7508582 |
| | | RCF3621STAM | 34800 [10.2] | 24700 [7.2] | 10100 [3.0] | 13 | 11.5 | 1025 [483.7] | 7508613 |
| RA1336AJ1 | R95TA0701317MSA | RCF3617STAM | 34600 [10.1] | 24500 [7.2] | 10100 [3.0] | 13 | 11 | 1025 [483.7] | 7508563 |
| | | RCF3621HTAM | 36000 [10.6] | 25400 [7.4] | 10600 [3.1] | 14.5 | 12 | 975 [460.1] | 8086582 |
| | | RCF3621MTAM | 36000 [10.6] | 24500 [7.2] | 11500 [3.4] | 14 | 11.5 | 1075 [507.3] | 7508583 |
| | | RCF3621STAM | 34200 [10.0] | 23700 [6.9] | 10500 [3.1] | 13 | 11.5 | 925 [436.6] | 7508614 |
| RA1336AJ1 | R95TA1151524MSA | RCF3624HTAM | 36000 [10.6] | 25600 [7.5] | 10400 [3.0] | 14 | 11.5 | 1325 [625.3] | 7508643 |
| | | RCF3624MTAM | 36000 [10.6] | 25400 [7.4] | 10600 [3.1] | 13.5 | 11.5 | 1275 [601.7] | 7508670 |
| RA1342AC1 | R95TA0401317MSA | RCF4821MTAM | 40500 [11.9] | 27300 [8.0] | 13200 [3.9] | 14 | 11.5 | 1125 [530.9] | 8086612 |
| | | RCF4821STAM | 39500 [11.6] | 28100 [8.2] | 11400 [3.3] | 13.5 | 11.5 | 1175 [554.5] | 7511564 |
| RA1342AC1 | R95TA0601317MSA | RCF4821MTAM | 40000 [11.7] | 26500 [7.8] | 13500 [4.0] | 13.5 | 11.5 | 1075 [507.3] | 8086613 |
| | | RCF4821STAM | 39000 [11.4] | 26900 [7.9] | 12100 [3.5] | 13.5 | 11.5 | 1050 [495.5] | 7511565 |
| RA1342AC1 | R95TA0701317MSA | RCF4821MTAM | 40000 [11.7] | 26500 [7.8] | 13500 [4.0] | 13.5 | 11.5 | 1075 [507.3] | 8086614 |
| | | RCF4821STAM | 39000 [11.4] | 27300 [8.0] | 11700 [3.4] | 13 | 11.5 | 1125 [530.9] | 7511566 |
| RA1342AC1 | R95TA0851521MSA | RCF4821MTAM | 41000 [12.0] | 29000 [8.5] | 12000 [3.5] | 13.5 | 11.5 | 1350 [637.1] | 8086615 |
| | | RCF4821STAM | 40000 [11.7] | 29400 [8.6] | 10600 [3.1] | 13 | 11.5 | 1325 [625.3] | 7511567 |
| | | RCF4824HTAM | 42000 [12.3] | 30500 [8.9] | 11500 [3.4] | 13.5 | 11.5 | 1500 [707.9] | 7511594 |
| | | RCF4824STAM | 40000 [11.7] | 29400 [8.6] | 10600 [3.1] | 13 | 11.5 | 1325 [625.3] | 7511622 |
| RA1342AC1 | R95TA1001521MSA | RCF4821MTAM | 41000 [12.0] | 29200 [8.6] | 11800 [3.5] | 13.5 | 11.5 | 1425 [672.5] | 8086616 |
| | | RCF4821STAM | 40500 [11.9] | 30300 [8.9] | 10200 [3.0] | 13 | 11.5 | 1400 [660.7] | 7511568 |
| | | RCF4824HTAM | 42000 [12.3] | 30200 [8.9] | 11800 [3.5] | 13.5 | 11.5 | 1450 [684.3] | 7511595 |
| | | RCF4824STAM | 40500 [11.9] | 30300 [8.9] | 10200 [3.0] | 13 | 11.5 | 1400 [660.7] | 7511623 |
| RA1342AC1 | R95TA1151524MSA | RCF4824HTAM | 42000 [12.3] | 30200 [8.9] | 11800 [3.5] | 13.5 | 11.5 | 1450 [684.3] | 7511596 |
| | | RCF4824STAM | 40500 [11.9] | 30300 [8.9] | 10200 [3.0] | 13 | 11.5 | 1425 [672.5] | 7511624 |
| RA1342AJ1 | R95TA0401317MSA | RCF4821MTAM | 40500 [11.9] | 27300 [8.0] | 13200 [3.9] | 14 | 11.5 | 1125 [530.9] | 8086668 |
| | | RCF4821STAM | 39500 [11.6] | 28100 [8.2] | 11400 [3.3] | 13.5 | 11.5 | 1175 [554.5] | 7511798 |
| RA1342AJ1 | R95TA0601317MSA | RCF4821MTAM | 40000 [11.7] | 26500 [7.8] | 13500 [4.0] | 13.5 | 11.5 | 1075 [507.3] | 8086669 |
| | | RCF4821STAM | 39000 [11.4] | 26900 [7.9] | 12100 [3.5] | 13.5 | 11.5 | 1050 [495.5] | 7511799 |
| RA1342AJ1 | R95TA0701317MSA | RCF4821MTAM | 40000 [11.7] | 26500 [7.8] | 13500 [4.0] | 13.5 | 11.5 | 1075 [507.3] | 8086670 |
| | | RCF4821STAM | 39000 [11.4] | 27300 [8.0] | 11700 [3.4] | 13 | 11.5 | 1125 [530.9] | 7511800 |
| RA1342AJ1 | R95TA0851521MSA | RCF4821MTAM | 41000 [12.0] | 29000 [8.5] | 12000 [3.5] | 13.5 | 11.5 | 1350 [637.1] | 8086671 |
| | | RCF4821STAM | 40000 [11.7] | 29400 [8.6] | 10600 [3.1] | 13 | 11.5 | 1325 [625.3] | 7511801 |
| | | RCF4824HTAM | 42000 [12.3] | 30500 [8.9] | 11500 [3.4] | 13.5 | 11.5 | 1500 [707.9] | 7511828 |
| | | RCF4824STAM | 40000 [11.7] | 29400 [8.6] | 10600 [3.1] | 13 | 11.5 | 1325 [625.3] | 7511856 |
| RA1342AJ1 | R95TA1001521MSA | RCF4821MTAM | 41000 [12.0] | 29200 [8.6] | 11800 [3.5] | 13.5 | 11.5 | 1425 [672.5] | 8086672 |
| | | RCF4821STAM | 40500 [11.9] | 30300 [8.9] | 10200 [3.0] | 13 | 11.5 | 1400 [660.7] | 7511802 |
| | | RCF4824HTAM | 42000 [12.3] | 30200 [8.9] | 11800 [3.5] | 13.5 | 11.5 | 1450 [684.3] | 7511829 |
| | | RCF4824STAM | 40500 [11.9] | 30300 [8.9] | 10200 [3.0] | 13 | 11.5 | 1400 [660.7] | 7511857 |
| RA1342AJ1 | R95TA1151524MSA | RCF4824HTAM | 42000 [12.3] | 30200 [8.9] | 11800 [3.5] | 13.5 | 11.5 | 1450 [684.3] | 7511830 |
| | | RCF4824STAM | 40500 [11.9] | 30300 [8.9] | 10200 [3.0] | 13 | 11.5 | 1425 [672.5] | 7511858 |

[] Designates Metric Conversions

Performance Data @ AHRI Standard Conditions – Cooling (con't.)

| R95T: 95% AFUE single-stage Constant Torque Multipoise Gas Furnace Ratings | | | | | | | | | |
|--|-----------------|-------------|------------------------------|----------------------------|--------------------------|------|------|---------------------|---------|
| Outdoor Unit | Furnace | Indoor Coil | Total Capacity BTU/H [kW] | Net Sensible BTU/H [kW] | Net Latent BTU/H [kW] | SEER | EER | Indoor CFM [L/s] | AHRI# |
| RA1348AC1 | R95TA0851521MSA | RCF4821MTAM | 48000 [14.1] | 34400 [10.1] | 13600 [4.0] | 13 | 11.5 | 1475 [696.1] | 8086722 |
| | | RCF4821STAM | 46500 [13.6] | 31900 [9.3] | 14600 [4.3] | 13 | 11 | 1300 [613.5] | 7508928 |
| | | RCF4824HTAM | 48000 [14.1] | 31700 [9.3] | 16300 [4.8] | 13.5 | 11.5 | 1350 [637.1] | 7508944 |
| | | RCF4824STAM | 46500 [13.6] | 31900 [9.3] | 14600 [4.3] | 13 | 11 | 1300 [613.5] | 7508982 |
| RA1348AC1 | R95TA1001521MSA | RCF4821MTAM | 48000 [14.1] | 34400 [10.1] | 13600 [4.0] | 13 | 11.5 | 1525 [719.7] | 8086723 |
| | | RCF4821STAM | 47000 [13.8] | 32800 [9.6] | 14200 [4.2] | 13 | 11 | 1375 [648.9] | 7508929 |
| | | RCF4824HTAM | 48000 [14.1] | 32200 [9.4] | 15800 [4.6] | 13.5 | 11.5 | 1425 [672.5] | 7508945 |
| | | RCF4824STAM | 47000 [13.8] | 32800 [9.6] | 14200 [4.2] | 13 | 11 | 1375 [648.9] | 7508984 |
| RA1348AC1 | R95TA1151524MSA | RCF4824HTAM | 48000 [14.1] | 33400 [9.8] | 14600 [4.3] | 13 | 11.5 | 1600 [755.1] | 7508946 |
| | | RCF4824STAM | 46500 [13.6] | 31700 [9.3] | 14800 [4.3] | 13 | 11.5 | 1275 [601.7] | 7508986 |
| RA1348AJ1 | R95TA0851521MSA | RCF4821MTAM | 48000 [14.1] | 34400 [10.1] | 13600 [4.0] | 13 | 11.5 | 1475 [696.1] | 8086758 |
| | | RCF4821STAM | 46500 [13.6] | 31900 [9.3] | 14600 [4.3] | 13 | 11 | 1300 [613.5] | 7509153 |
| | | RCF4824HTAM | 48000 [14.1] | 31700 [9.3] | 16300 [4.8] | 13.5 | 11.5 | 1350 [637.1] | 7509169 |
| | | RCF4824STAM | 46500 [13.6] | 31900 [9.3] | 14600 [4.3] | 13 | 11 | 1300 [613.5] | 7509194 |
| RA1348AJ1 | R95TA1001521MSA | RCF4821MTAM | 48000 [14.1] | 34400 [10.1] | 13600 [4.0] | 13 | 11.5 | 1525 [719.7] | 8086759 |
| | | RCF4821STAM | 47000 [13.8] | 32800 [9.6] | 14200 [4.2] | 13 | 11 | 1375 [648.9] | 7509154 |
| | | RCF4824HTAM | 48000 [14.1] | 32200 [9.4] | 15800 [4.6] | 13.5 | 11.5 | 1425 [672.5] | 7509170 |
| | | RCF4824STAM | 47000 [13.8] | 32800 [9.6] | 14200 [4.2] | 13 | 11 | 1375 [648.9] | 7509195 |
| RA1348AJ1 | R95TA1151524MSA | RCF4824HTAM | 48000 [14.1] | 33400 [9.8] | 14600 [4.3] | 13 | 11.5 | 1600 [755.1] | 7509171 |
| | | RCF4824STAM | 46500 [13.6] | 31700 [9.3] | 14800 [4.3] | 13 | 11.5 | 1275 [601.7] | 7509196 |
| RA1360AC1 | R95TA0851521MSA | RCF6021STAM | 53500 [15.7] | 34400 [10.1] | 19100 [5.6] | 13 | 11 | 1375 [648.9] | 8086790 |
| | | RCF6024HTAM | 55500 [16.3] | 38200 [11.2] | 17300 [5.1] | 13 | 11 | 1475 [696.1] | 7509296 |
| | | RCF6024STAM | 55500 [16.3] | 38200 [11.2] | 17300 [5.1] | 13 | 11 | 1475 [696.1] | 7509320 |
| RA1360AC1 | R95TA1001521MSA | RCF6021STAM | 53500 [15.7] | 34800 [10.2] | 18700 [5.5] | 13 | 11 | 1425 [672.5] | 8086791 |
| | | RCF6024HTAM | 56000 [16.4] | 39300 [11.5] | 16700 [4.9] | 13 | 11 | 1550 [731.5] | 7509297 |
| | | RCF6024STAM | 56000 [16.4] | 39300 [11.5] | 16700 [4.9] | 13 | 11 | 1550 [731.5] | 7509321 |
| RA1360AC1 | R95TA1151524MSA | RCF6024HTAM | 55500 [16.3] | 37900 [11.1] | 17600 [5.2] | 13 | 11 | 1425 [672.5] | 7509298 |
| | | RCF6024STAM | 55500 [16.3] | 37900 [11.1] | 17600 [5.2] | 13 | 11 | 1425 [672.5] | 7509322 |
| RA1360AJ1 | R95TA0851521MSA | RCF6021STAM | 53500 [15.7] | 34400 [10.1] | 19100 [5.6] | 13 | 11 | 1375 [648.9] | 8086808 |
| | | RCF6024HTAM | 55500 [16.3] | 38200 [11.2] | 17300 [5.1] | 13 | 11 | 1475 [696.1] | 7509418 |
| | | RCF6024STAM | 55500 [16.3] | 38200 [11.2] | 17300 [5.1] | 13 | 11 | 1475 [696.1] | 7509442 |
| RA1360AJ1 | R95TA1001521MSA | RCF6021STAM | 53500 [15.7] | 34800 [10.2] | 18700 [5.5] | 13 | 11 | 1425 [672.5] | 8086809 |
| | | RCF6024HTAM | 56000 [16.4] | 39300 [11.5] | 16700 [4.9] | 13 | 11 | 1550 [731.5] | 7509419 |
| | | RCF6024STAM | 56000 [16.4] | 39300 [11.5] | 16700 [4.9] | 13 | 11 | 1550 [731.5] | 7509443 |
| RA1360AJ1 | R95TA1151524MSA | RCF6024HTAM | 55500 [16.3] | 37900 [11.1] | 17600 [5.2] | 13 | 11 | 1425 [672.5] | 7509420 |
| | | RCF6024STAM | 55500 [16.3] | 37900 [11.1] | 17600 [5.2] | 13 | 11 | 1425 [672.5] | 7509444 |

[] Designates Metric Conversions

Performance Data @ AHRI Standard Conditions – Cooling (con't.)

| R96V: 96% AFUE 2-stage Variable Speed Multipoise Gas Furnace Ratings | | | | | | | | | |
|--|-----------------|-------------|------------------------------|----------------------------|--------------------------|------|------|---------------------|---------|
| Outdoor Unit | Furnace | Indoor Coil | Total Capacity BTU/H [kW] | Net Sensible BTU/H [kW] | Net Latent BTU/H [kW] | SEER | EER | Indoor CFM [L/s] | AHRI# |
| RA1318AJ1 | R96VA0402317MSA | RCF2417HTAM | 18000 [5.3] | 13400 [3.9] | 4600 [1.3] | 14.5 | 12 | 675 [318.6] | 7982148 |
| | | RCF2417MTAM | 18000 [5.3] | 13400 [3.9] | 4600 [1.3] | 14.5 | 12 | 675 [318.6] | 7982157 |
| | | RCF2417STAM | 18000 [5.3] | 13400 [3.9] | 4600 [1.3] | 14.5 | 12 | 675 [318.6] | 7982166 |
| | | RCF2421MTAM | 18000 [5.3] | 13400 [3.9] | 4600 [1.3] | 14.5 | 12 | 675 [318.6] | 7982184 |
| RA1318AJ1 | R96VA0602317MSA | RCF2417HTAM | 18000 [5.3] | 13400 [3.9] | 4600 [1.3] | 14.5 | 12 | 650 [306.8] | 8050160 |
| | | RCF2417MTAM | 18000 [5.3] | 13400 [3.9] | 4600 [1.3] | 14.5 | 12 | 650 [306.8] | 8050167 |
| | | RCF2417STAM | 18000 [5.3] | 13400 [3.9] | 4600 [1.3] | 14 | 11.5 | 650 [306.8] | 8050174 |
| | | RCF2421MTAM | 18000 [5.3] | 13400 [3.9] | 4600 [1.3] | 14.5 | 12 | 650 [306.8] | 8050188 |
| RA1318AJ1 | R96VA0702317MSA | RCF2417HTAM | 18000 [5.3] | 13400 [3.9] | 4600 [1.3] | 14.5 | 12 | 650 [306.8] | 8050161 |
| | | RCF2417MTAM | 18000 [5.3] | 13400 [3.9] | 4600 [1.3] | 14.5 | 12 | 650 [306.8] | 8050168 |
| | | RCF2417STAM | 18000 [5.3] | 13400 [3.9] | 4600 [1.3] | 14.5 | 12 | 650 [306.8] | 8050175 |
| | | RCF2421MTAM | 18000 [5.3] | 13400 [3.9] | 4600 [1.3] | 14.5 | 12 | 650 [306.8] | 8050189 |
| RA1318AJ1 | R96VA0402317MSA | RCF2421HTAM | 18000 [5.3] | 13400 [3.9] | 4600 [1.3] | 14.5 | 12 | 675 [318.6] | 7982175 |
| RA1318AJ1 | R96VA0602317MSA | RCF2421HTAM | 18000 [5.3] | 13400 [3.9] | 4600 [1.3] | 14.5 | 12 | 650 [306.8] | 8050181 |
| RA1318AJ1 | R96VA0702317MSA | RCF2421HTAM | 18000 [5.3] | 13400 [3.9] | 4600 [1.3] | 14.5 | 12 | 650 [306.8] | 8050182 |
| RA1324AJ1 | R96VA0402317MSA | RCF2417HTAM | 24000 [7.0] | 17900 [5.2] | 6100 [1.8] | 14 | 11.5 | 875 [413.0] | 7982246 |
| | | RCF2417MTAM | 24000 [7.0] | 17900 [5.2] | 6100 [1.8] | 14 | 11.5 | 875 [413.0] | 7982255 |
| | | RCF2417STAM | 24000 [7.0] | 17900 [5.2] | 6100 [1.8] | 14 | 11.5 | 875 [413.0] | 7982264 |
| | | RCF2421MTAM | 24000 [7.0] | 17900 [5.2] | 6100 [1.8] | 14 | 11.5 | 875 [413.0] | 7982282 |
| RA1324AJ1 | R96VA0602317MSA | RCF2417HTAM | 24000 [7.0] | 17300 [5.1] | 6700 [2.0] | 14 | 11.5 | 850 [401.2] | 8050237 |
| | | RCF2417MTAM | 24000 [7.0] | 17000 [5.0] | 7000 [2.1] | 14 | 11.5 | 775 [365.8] | 8050244 |
| | | RCF2417STAM | 23800 [7.0] | 17800 [5.2] | 6000 [1.8] | 14 | 11.5 | 775 [365.8] | 8050252 |
| | | RCF2421MTAM | 24000 [7.0] | 17000 [5.0] | 7000 [2.1] | 14 | 11.5 | 775 [365.8] | 8050270 |
| RA1324AJ1 | R96VA0702317MSA | RCF2417HTAM | 24000 [7.0] | 17900 [5.2] | 6100 [1.8] | 14 | 11.5 | 875 [413.0] | 8050238 |
| | | RCF2417MTAM | 24000 [7.0] | 17900 [5.2] | 6100 [1.8] | 14 | 11.5 | 875 [413.0] | 8050245 |
| | | RCF2417STAM | 24000 [7.0] | 17900 [5.2] | 6100 [1.8] | 14 | 11.5 | 875 [413.0] | 8050253 |
| | | RCF2421MTAM | 24000 [7.0] | 17900 [5.2] | 6100 [1.8] | 14 | 11.5 | 875 [413.0] | 8050271 |
| RA1324AJ1 | R96VA0402317MSA | RCF2421HTAM | 24000 [7.0] | 17900 [5.2] | 6100 [1.8] | 14 | 11.5 | 875 [413.0] | 7982276 |
| RA1324AJ1 | R96VA0602317MSA | RCF2421HTAM | 24000 [7.0] | 17000 [5.0] | 7000 [2.1] | 14 | 11.5 | 775 [365.8] | 8050261 |
| RA1324AJ1 | R96VA0702317MSA | RCF2421HTAM | 24000 [7.0] | 17900 [5.2] | 6100 [1.8] | 14 | 11.5 | 875 [413.0] | 8050262 |
| RA1330AJ1 | R96VA0402317MSA | RCF3617STAM | 28600 [8.4] | 21700 [6.4] | 6900 [2.0] | 14 | 11.5 | 950 [448.4] | 7982310 |
| | | RCF3621HTAM | 30000 [8.8] | 22900 [6.7] | 7100 [2.1] | 15.1 | 12.5 | 875 [413.0] | 8086527 |
| | | RCF3621MTAM | 30000 [8.8] | 22900 [6.7] | 7100 [2.1] | 14.5 | 12 | 950 [448.4] | 7982317 |
| | | RCF3621STAM | 28600 [8.4] | 21700 [6.4] | 6900 [2.0] | 14 | 11.5 | 950 [448.4] | 7982324 |
| RA1330AJ1 | R96VA0602317MSA | RCF3621HTAM | 30000 [8.8] | 22900 [6.7] | 7100 [2.1] | 14.5 | 12 | 1050 [495.5] | 8086528 |
| RA1330AJ1 | R96VA0702317MSA | RCF3617STAM | 28600 [8.4] | 21700 [6.4] | 6900 [2.0] | 14 | 11.5 | 950 [448.4] | 8050319 |
| | | RCF3621HTAM | 29800 [8.7] | 21300 [6.2] | 8500 [2.5] | 15.1 | 12.5 | 800 [377.6] | 8086529 |
| | | RCF3621MTAM | 30000 [8.8] | 22900 [6.7] | 7100 [2.1] | 14.5 | 12 | 950 [448.4] | 8050333 |
| | | RCF3621STAM | 28600 [8.4] | 21700 [6.4] | 6900 [2.0] | 14 | 11.5 | 950 [448.4] | 8050347 |
| RA1330AJ1 | R96VA0852521MSB | RCF3621HTAM | 30000 [8.8] | 22900 [6.7] | 7100 [2.1] | 15.1 | 12.5 | 975 [460.1] | 8086530 |
| RA1330AJ1 | R96VA1002521MSA | RCF3621HTAM | 30000 [8.8] | 22900 [6.7] | 7100 [2.1] | 15.1 | 12.5 | 1050 [495.5] | 8086531 |
| RA1336AC1 | R96VA0402317MSA | RCF3617STAM | 34800 [10.2] | 24700 [7.2] | 10100 [3.0] | 13.5 | 11.5 | 1025 [483.7] | 7982372 |
| | | RCF3621HTAM | 36000 [10.6] | 25400 [7.4] | 10600 [3.1] | 14.5 | 12 | 1125 [530.9] | 8086555 |
| | | RCF3621MTAM | 36000 [10.6] | 25400 [7.4] | 10600 [3.1] | 14 | 11.5 | 1125 [530.9] | 7982379 |
| | | RCF3621STAM | 34800 [10.2] | 24700 [7.2] | 10100 [3.0] | 13.5 | 11.5 | 1025 [483.7] | 7982386 |
| RA1336AC1 | R96VA0602317MSA | RCF3617STAM | 34600 [10.1] | 24300 [7.1] | 10300 [3.0] | 13 | 11.5 | 975 [460.1] | 8050445 |
| | | RCF3621HTAM | 36000 [10.6] | 25400 [7.4] | 10600 [3.1] | 14.5 | 12 | 975 [460.1] | 8086556 |
| | | RCF3621MTAM | 36000 [10.6] | 25400 [7.4] | 10600 [3.1] | 14 | 11.5 | 1050 [495.5] | 8050460 |
| | | RCF3621STAM | 34400 [10.1] | 24000 [7.0] | 10400 [3.0] | 13.5 | 11.5 | 950 [448.4] | 8050476 |

[] Designates Metric Conversions

Performance Data @ AHRI Standard Conditions – Cooling (con't.)

| R96V: 96% AFUE 2-stage Variable Speed Multiphase Gas Furnace Ratings | | | | | | | | | |
|--|-----------------|-------------|------------------------------|----------------------------|--------------------------|------|------|---------------------|---------|
| Outdoor Unit | Furnace | Indoor Coil | Total Capacity BTU/H [kW] | Net Sensible BTU/H [kW] | Net Latent BTU/H [kW] | SEER | EER | Indoor CFM [L/s] | AHRI# |
| RA1336AC1 | R96VA0702317MSA | RCF3617STAM | 34400 [10.1] | 24000 [7.0] | 10400 [3.0] | 13.5 | 11.5 | 950 [448.4] | 8050446 |
| | | RCF3621HTAM | 36000 [10.6] | 25400 [7.4] | 10600 [3.1] | 14.5 | 12 | 1050 [495.5] | 8086557 |
| | | RCF3621MTAM | 36000 [10.6] | 25400 [7.4] | 10600 [3.1] | 14 | 11.5 | 1150 [542.7] | 8050461 |
| | | RCF3621STAM | 34600 [10.1] | 24200 [7.1] | 10400 [3.0] | 13.5 | 11.5 | 950 [448.4] | 8050477 |
| RA1336AC1 | R96VA0852521MSB | RCF3621HTAM | 36000 [10.6] | 25400 [7.4] | 10600 [3.1] | 14.5 | 12 | 1275 [601.7] | 8086558 |
| | | RCF3621MTAM | 36000 [10.6] | 25400 [7.4] | 10600 [3.1] | 14.5 | 12 | 1025 [483.7] | 8050462 |
| | | RCF3621STAM | 35600 [10.4] | 26000 [7.6] | 9600 [2.8] | 13.5 | 11.5 | 1150 [542.7] | 8050478 |
| | | RCF3624HTAM | 36000 [10.6] | 25400 [7.4] | 10600 [3.1] | 15 | 12.5 | 1075 [507.3] | 8050491 |
| | | RCF3624MTAM | 36000 [10.6] | 25400 [7.4] | 10600 [3.1] | 14.5 | 12 | 1025 [483.7] | 8050504 |
| RA1336AC1 | R96VA1002521MSA | RCF3621HTAM | 36000 [10.6] | 25400 [7.4] | 10600 [3.1] | 15 | 12.5 | 1000 [471.9] | 8086559 |
| RA1336AJ1 | R96VA0402317MSA | RCF3617STAM | 34800 [10.2] | 24700 [7.2] | 10100 [3.0] | 13.5 | 11.5 | 1025 [483.7] | 7982429 |
| | | RCF3621HTAM | 36000 [10.6] | 25400 [7.4] | 10600 [3.1] | 14.5 | 12 | 1125 [530.9] | 8086583 |
| | | RCF3621MTAM | 36000 [10.6] | 25400 [7.4] | 10600 [3.1] | 14 | 11.5 | 1125 [530.9] | 7982436 |
| | | RCF3621STAM | 34800 [10.2] | 24700 [7.2] | 10100 [3.0] | 13.5 | 11.5 | 1025 [483.7] | 7982443 |
| RA1336AJ1 | R96VA0602317MSA | RCF3617STAM | 34600 [10.1] | 24300 [7.1] | 10300 [3.0] | 13 | 11.5 | 975 [460.1] | 8050590 |
| | | RCF3621HTAM | 36000 [10.6] | 25400 [7.4] | 10600 [3.1] | 14.5 | 12 | 975 [460.1] | 8086584 |
| | | RCF3621MTAM | 36000 [10.6] | 25400 [7.4] | 10600 [3.1] | 14 | 11.5 | 1050 [495.5] | 8050605 |
| | | RCF3621STAM | 34400 [10.1] | 24000 [7.0] | 10400 [3.0] | 13.5 | 11.5 | 950 [448.4] | 8050622 |
| RA1336AJ1 | R96VA0702317MSA | RCF3617STAM | 34400 [10.1] | 24000 [7.0] | 10400 [3.0] | 13.5 | 11.5 | 950 [448.4] | 8050591 |
| | | RCF3621HTAM | 36000 [10.6] | 25400 [7.4] | 10600 [3.1] | 14.5 | 12 | 1050 [495.5] | 8086585 |
| | | RCF3621MTAM | 36000 [10.6] | 25400 [7.4] | 10600 [3.1] | 14 | 11.5 | 1150 [542.7] | 8050606 |
| | | RCF3621STAM | 34600 [10.1] | 24200 [7.1] | 10400 [3.0] | 13.5 | 11.5 | 950 [448.4] | 8050623 |
| RA1336AJ1 | R96VA0852521MSB | RCF3621HTAM | 36000 [10.6] | 25400 [7.4] | 10600 [3.1] | 14.5 | 12 | 1275 [601.7] | 8086586 |
| | | RCF3621MTAM | 36000 [10.6] | 25400 [7.4] | 10600 [3.1] | 14.5 | 12 | 1025 [483.7] | 8050607 |
| | | RCF3621STAM | 35600 [10.4] | 26000 [7.6] | 9600 [2.8] | 13.5 | 11.5 | 1150 [542.7] | 8050624 |
| | | RCF3624HTAM | 36000 [10.6] | 25400 [7.4] | 10600 [3.1] | 15 | 12.5 | 1075 [507.3] | 8050649 |
| | | RCF3624MTAM | 36000 [10.6] | 25400 [7.4] | 10600 [3.1] | 14.5 | 12 | 1025 [483.7] | 8050684 |
| RA1336AJ1 | R96VA1002521MSA | RCF3621HTAM | 36000 [10.6] | 25400 [7.4] | 10600 [3.1] | 15 | 12.5 | 1000 [471.9] | 8086587 |
| RA1342AC1 | R96VA0402317MSA | RCF4821MTAM | 40000 [11.7] | 26800 [7.9] | 13200 [3.9] | 13.5 | 11.5 | 1125 [530.9] | 8086617 |
| RA1342AC1 | R96VA0602317MSA | RCF4821MTAM | 40000 [11.7] | 26800 [7.9] | 13200 [3.9] | 13.5 | 11.5 | 1125 [530.9] | 8086618 |
| RA1342AC1 | R96VA0702317MSA | RCF4821MTAM | 40500 [11.9] | 27400 [8.0] | 13100 [3.8] | 13.5 | 11.5 | 1150 [542.7] | 8086619 |
| RA1342AC1 | R96VA0852521MSB | RCF4821MTAM | 40500 [11.9] | 27800 [8.1] | 12700 [3.7] | 14 | 11.5 | 1225 [578.1] | 8086620 |
| | | RCF4821STAM | 40000 [11.7] | 29100 [8.5] | 10900 [3.2] | 13.5 | 11.5 | 1275 [601.7] | 8049110 |
| | | RCF4824HTAM | 41500 [12.2] | 28900 [8.5] | 12600 [3.7] | 14 | 11.5 | 1300 [613.5] | 8049116 |
| | | RCF4824STAM | 40000 [11.7] | 29100 [8.5] | 10900 [3.2] | 13.5 | 11.5 | 1275 [601.7] | 8049121 |
| RA1342AC1 | R96VA1002521MSA | RCF4821MTAM | 41000 [12.0] | 28400 [8.3] | 12600 [3.7] | 14 | 11.5 | 1250 [589.9] | 8086621 |
| | | RCF4821STAM | 40500 [11.9] | 30000 [8.8] | 10500 [3.1] | 13.5 | 11.5 | 1350 [637.1] | 8049111 |
| | | RCF4824HTAM | 42000 [12.3] | 29900 [8.8] | 12100 [3.5] | 14 | 11.5 | 1400 [660.7] | 8049117 |
| | | RCF4824STAM | 40500 [11.9] | 30000 [8.8] | 10500 [3.1] | 13.5 | 11.5 | 1350 [637.1] | 8049122 |
| RA1342AC1 | R96VA1152524MSA | RCF4824HTAM | 41500 [12.2] | 28600 [8.4] | 12900 [3.8] | 14.5 | 12 | 1250 [589.9] | 8049118 |
| | | RCF4824STAM | 40000 [11.7] | 29000 [8.5] | 11000 [3.2] | 14 | 11.5 | 1250 [589.9] | 8049123 |
| RA1342AJ1 | R96VA0402317MSA | RCF4821MTAM | 40000 [11.7] | 26800 [7.9] | 13200 [3.9] | 13.5 | 11.5 | 1125 [530.9] | 8086673 |
| RA1342AJ1 | R96VA0602317MSA | RCF4821MTAM | 40000 [11.7] | 26800 [7.9] | 13200 [3.9] | 13.5 | 11.5 | 1125 [530.9] | 8086674 |
| RA1342AJ1 | R96VA0702317MSA | RCF4821MTAM | 40500 [11.9] | 27400 [8.0] | 13100 [3.8] | 13.5 | 11.5 | 1150 [542.7] | 8086675 |
| RA1342AJ1 | R96VA0852521MSB | RCF4821MTAM | 40500 [11.9] | 27800 [8.1] | 12700 [3.7] | 14 | 11.5 | 1225 [578.1] | 8086676 |
| | | RCF4821STAM | 40000 [11.7] | 29100 [8.5] | 10900 [3.2] | 13.5 | 11.5 | 1275 [601.7] | 8049142 |
| | | RCF4824HTAM | 41500 [12.2] | 28900 [8.5] | 12600 [3.7] | 14 | 11.5 | 1300 [613.5] | 8049148 |
| | | RCF4824STAM | 40000 [11.7] | 29100 [8.5] | 10900 [3.2] | 13.5 | 11.5 | 1275 [601.7] | 8049153 |

[] Designates Metric Conversions



Performance Data @ AHRI Standard Conditions – Cooling (con't.)

| R96V: 96% AFUE 2-stage Variable Speed Multipoise Gas Furnace Ratings | | | | | | | | | |
|--|-----------------|-------------|------------------------------|----------------------------|--------------------------|------|------|---------------------|---------|
| Outdoor Unit | Furnace | Indoor Coil | Total Capacity BTU/H [kW] | Net Sensible BTU/H [kW] | Net Latent BTU/H [kW] | SEER | EER | Indoor CFM [L/s] | AHRI# |
| RA1342AJ1 | R96VA1002521MSA | RCF4821MTAM | 41000 [12.0] | 28400 [8.3] | 12600 [3.7] | 14 | 11.5 | 1250 [589.9] | 8086677 |
| | | RCF4821STAM | 40500 [11.9] | 30000 [8.8] | 10500 [3.1] | 13.5 | 11.5 | 1350 [637.1] | 8049143 |
| | | RCF4824HTAM | 42000 [12.3] | 29900 [8.8] | 12100 [3.5] | 14 | 11.5 | 1400 [660.7] | 8049149 |
| | | RCF4824STAM | 40500 [11.9] | 30000 [8.8] | 10500 [3.1] | 13.5 | 11.5 | 1350 [637.1] | 8049154 |
| RA1342AJ1 | R96VA1152524MSA | RCF4824HTAM | 41500 [12.2] | 28600 [8.4] | 12900 [3.8] | 14.5 | 12 | 1250 [589.9] | 8049150 |
| | | RCF4824STAM | 40000 [11.7] | 29000 [8.5] | 11000 [3.2] | 14 | 11.5 | 1250 [589.9] | 8049155 |
| RA1348AC1 | R96VA0852521MSB | RCF4821MTAM | 47500 [13.9] | 31000 [9.1] | 16500 [4.8] | 13.5 | 11.5 | 1275 [601.7] | 8086724 |
| | | RCF4821STAM | 46500 [13.6] | 31900 [9.3] | 14600 [4.3] | 13 | 11.5 | 1300 [613.5] | 8049175 |
| | | RCF4824HTAM | 48000 [14.1] | 34400 [10.1] | 13600 [4.0] | 13.5 | 11.5 | 1350 [637.1] | 8049180 |
| | | RCF4824STAM | 46500 [13.6] | 31900 [9.3] | 14600 [4.3] | 13 | 11.5 | 1300 [613.5] | 8049185 |
| RA1348AC1 | R96VA1002521MSA | RCF4821MTAM | 48000 [14.1] | 32000 [9.4] | 16000 [4.7] | 13.5 | 11.5 | 1350 [637.1] | 8086725 |
| | | RCF4821STAM | 47000 [13.8] | 32700 [9.6] | 14300 [4.2] | 13 | 11.5 | 1350 [637.1] | 8049176 |
| | | RCF4824HTAM | 48000 [14.1] | 34400 [10.1] | 13600 [4.0] | 13.5 | 11.5 | 1475 [696.1] | 8049181 |
| | | RCF4824STAM | 47000 [13.8] | 32700 [9.6] | 14300 [4.2] | 13 | 11.5 | 1350 [637.1] | 8049186 |
| RA1348AC1 | R96VA1152524MSA | RCF4824HTAM | 48000 [14.1] | 34400 [10.1] | 13600 [4.0] | 14 | 11.5 | 1350 [637.1] | 8049182 |
| | | RCF4824STAM | 46500 [13.6] | 31600 [9.3] | 14900 [4.4] | 13.5 | 11.5 | 1250 [589.9] | 8049187 |
| RA1348AJ1 | R96VA0852521MSB | RCF4821MTAM | 47500 [13.9] | 31000 [9.1] | 16500 [4.8] | 13.5 | 11.5 | 1275 [601.7] | 8086760 |
| | | RCF4821STAM | 46500 [13.6] | 31900 [9.3] | 14600 [4.3] | 13 | 11.5 | 1300 [613.5] | 8049210 |
| | | RCF4824HTAM | 48000 [14.1] | 34400 [10.1] | 13600 [4.0] | 13.5 | 11.5 | 1350 [637.1] | 8049215 |
| | | RCF4824STAM | 46500 [13.6] | 31900 [9.3] | 14600 [4.3] | 13 | 11.5 | 1300 [613.5] | 8049220 |
| RA1348AJ1 | R96VA1002521MSA | RCF4821MTAM | 48000 [14.1] | 32000 [9.4] | 16000 [4.7] | 13.5 | 11.5 | 1350 [637.1] | 8086761 |
| | | RCF4821STAM | 47000 [13.8] | 32700 [9.6] | 14300 [4.2] | 13 | 11.5 | 1350 [637.1] | 8049211 |
| | | RCF4824HTAM | 48000 [14.1] | 34400 [10.1] | 13600 [4.0] | 13.5 | 11.5 | 1475 [696.1] | 8049216 |
| | | RCF4824STAM | 47000 [13.8] | 32700 [9.6] | 14300 [4.2] | 13 | 11.5 | 1350 [637.1] | 8049221 |
| RA1348AJ1 | R96VA1152524MSA | RCF4824HTAM | 48000 [14.1] | 34400 [10.1] | 13600 [4.0] | 14 | 11.5 | 1350 [637.1] | 8049217 |
| | | RCF4824STAM | 46500 [13.6] | 31600 [9.3] | 14900 [4.4] | 13.5 | 11.5 | 1250 [589.9] | 8049222 |
| RA1360AC1 | R96VA0852521MSB | RCF6024HTAM | 56500 [16.6] | 40000 [11.7] | 16500 [4.8] | 13 | 11 | 1575 [743.3] | 8049246 |
| | | RCF6024STAM | 56500 [16.6] | 40000 [11.7] | 16500 [4.8] | 13 | 11 | 1575 [743.3] | 8049251 |
| RA1360AC1 | R96VA1002521MSA | RCF6021STAM | 54500 [16.0] | 35200 [10.3] | 19300 [5.7] | 13 | 11 | 1400 [660.7] | 8086792 |
| | | RCF6024HTAM | 56500 [16.6] | 40400 [11.8] | 16100 [4.7] | 13 | 11 | 1625 [766.9] | 8049247 |
| | | RCF6024STAM | 56500 [16.6] | 40400 [11.8] | 16100 [4.7] | 13 | 11 | 1625 [766.9] | 8049252 |
| RA1360AC1 | R96VA1152524MSA | RCF6024HTAM | 56500 [16.6] | 40000 [11.7] | 16500 [4.8] | 13.5 | 11.5 | 1575 [743.3] | 8049248 |
| | | RCF6024STAM | 56500 [16.6] | 40000 [11.7] | 16500 [4.8] | 13.5 | 11.5 | 1575 [743.3] | 8049253 |
| RA1360AJ1 | R96VA0852521MSB | RCF6024HTAM | 56500 [16.6] | 40000 [11.7] | 16500 [4.8] | 13 | 11 | 1575 [743.3] | 8049277 |
| | | RCF6024STAM | 56500 [16.6] | 40000 [11.7] | 16500 [4.8] | 13 | 11 | 1575 [743.3] | 8049282 |
| RA1360AJ1 | R96VA1002521MSA | RCF6021STAM | 54500 [16.0] | 35200 [10.3] | 19300 [5.7] | 13 | 11 | 1400 [660.7] | 8086810 |
| | | RCF6024HTAM | 56500 [16.6] | 40400 [11.8] | 16100 [4.7] | 13 | 11 | 1625 [766.9] | 8049278 |
| | | RCF6024STAM | 56500 [16.6] | 40400 [11.8] | 16100 [4.7] | 13 | 11 | 1625 [766.9] | 8049283 |
| RA1360AJ1 | R96VA1152524MSA | RCF6024HTAM | 56500 [16.6] | 40000 [11.7] | 16500 [4.8] | 13.5 | 11.5 | 1575 [743.3] | 8049279 |
| | | RCF6024STAM | 56500 [16.6] | 40000 [11.7] | 16500 [4.8] | 13.5 | 11.5 | 1575 [743.3] | 8049284 |

[] Designates Metric Conversions

Performance Data @ AHRI Standard Conditions – Cooling (con't.)

| Air Handler Ratings | | | | | | | | |
|---------------------|--------------|------------------------------|----------------------------|--------------------------|------|------|---------------------|---------|
| Outdoor Unit | Air Handler | Total Capacity BTU/H [kW] | Net Sensible BTU/H [kW] | Net Latent BTU/H [kW] | SEER | EER | Indoor CFM [L/s] | AHRI# |
| RA1318AJ1 | RF1T2421MTAN | 18000 [5.3] | 13400 [3.9] | 4600 [1.3] | 14.5 | 12 | 625 [295.0] | 7886604 |
| | RBHP-17 | 17800 [5.2] | 11800 [3.5] | 6000 [1.8] | 14 | 11.5 | 600 [283.2] | 7507406 |
| | RH1P1817STAN | 17700 [5.2] | 13200 [3.9] | 4500 [1.3] | 13 | 11.5 | 600 [283.2] | 7507603 |
| | RH1T2417STAN | 18000 [5.3] | 13500 [4.0] | 4500 [1.3] | 14.5 | 12 | 600 [283.2] | 7507604 |
| | RH1V2417STAN | 18000 [5.3] | 13600 [4.0] | 4400 [1.3] | 14.5 | 12 | 650 [306.8] | 7507605 |
| RA1324AJ1 | RF1T2421MTAN | 24000 [7.0] | 17400 [5.1] | 6600 [1.9] | 14 | 11.5 | 800 [377.6] | 7886607 |
| | RBHP-17 | 23800 [7.0] | 15700 [4.6] | 8100 [2.4] | 14 | 11.5 | 800 [377.6] | 7507610 |
| | RH1P2417STAN | 23600 [6.9] | 17600 [5.2] | 6000 [1.8] | 13 | 11.5 | 800 [377.6] | 7507835 |
| | RH1T2417STAN | 24000 [7.0] | 18000 [5.3] | 6000 [1.8] | 14.5 | 12 | 800 [377.6] | 7507836 |
| | RH2T2421MTAN | 23600 [6.9] | 16500 [4.8] | 7100 [2.1] | 14 | 11.5 | 700 [330.4] | 7507838 |
| RA1330AJ1 | RH1V2417STAN | 24000 [7.0] | 18200 [5.3] | 5800 [1.7] | 14 | 11.5 | 850 [401.2] | 7507837 |
| | RF1P3024SPAN | 29200 [8.6] | 21400 [6.3] | 7800 [2.3] | 13 | 11.5 | 900 [424.8] | 7886610 |
| | RF1T3624MTAN | 30000 [8.8] | 22900 [6.7] | 7100 [2.1] | 14.5 | 12 | 1025 [483.7] | 7886612 |
| | RBHP-21 | 29600 [8.7] | 20200 [5.9] | 9400 [2.8] | 14.5 | 12 | 1000 [471.9] | 7507845 |
| | RH1P3017STAN | 28600 [8.4] | 21700 [6.4] | 6900 [2.0] | 13 | 11.5 | 975 [460.1] | 7508177 |
| | RH1T3617STAN | 29000 [8.5] | 22200 [6.5] | 6800 [2.0] | 14.5 | 12 | 1000 [471.9] | 7508178 |
| | RH1T3621HTAN | 30000 [8.8] | 22900 [6.7] | 7100 [2.1] | 15.5 | 13 | 1000 [471.9] | 8086541 |
| | RH1T3621MTAN | 30000 [8.8] | 22100 [6.5] | 7900 [2.3] | 15 | 12.5 | 1000 [471.9] | 7508179 |
| | RH1V3617STAN | 29000 [8.5] | 22300 [6.5] | 6700 [2.0] | 14 | 11.5 | 1025 [483.7] | 7508180 |
| | RH1V3621HTAN | 30000 [8.8] | 22900 [6.7] | 7100 [2.1] | 15.5 | 13 | 1000 [471.9] | 8086542 |
| RA1336AC1 | RH1V3621MTAN | 30000 [8.8] | 22100 [6.5] | 7900 [2.3] | 15 | 12.5 | 1000 [471.9] | 7508181 |
| | RH2V3624HTAC | 32200 [9.4] | 24800 [7.3] | 7400 [2.2] | 15 | 12.5 | 1200 [566.3] | 7508182 |
| | RF1P3624SPAN | 36000 [10.6] | 25400 [7.4] | 10600 [3.1] | 13 | 11.5 | 1100 [519.1] | 7886615 |
| | RF1P3624STAN | 36000 [10.6] | 25400 [7.4] | 10600 [3.1] | 13 | 11.5 | 1100 [519.1] | 7886618 |
| | RF1T3624MTAN | 36000 [10.6] | 25400 [7.4] | 10600 [3.1] | 14.5 | 12 | 1025 [483.7] | 7886621 |
| | RBHP-21 | 36000 [10.6] | 24100 [7.1] | 11900 [3.5] | 14 | 11.5 | 1200 [566.3] | 7508190 |
| | RH1P3017STAN | 34200 [10.0] | 23800 [7.0] | 10400 [3.0] | 13 | 11 | 950 [448.4] | 7508541 |
| | RH1T3617STAN | 35200 [10.3] | 24900 [7.3] | 10300 [3.0] | 14 | 11.5 | 1000 [471.9] | 7508542 |
| | RH1T3621HTAN | 36000 [10.6] | 25400 [7.4] | 10600 [3.1] | 15 | 12.5 | 1200 [566.3] | 8086569 |
| | RH1T3621MTAN | 36000 [10.6] | 25000 [7.3] | 11000 [3.2] | 14.5 | 12 | 1175 [554.5] | 7508543 |
| RA1336AJ1 | RH1V3617STAN | 36000 [10.6] | 26800 [7.9] | 9200 [2.7] | 13.5 | 11.5 | 1225 [578.1] | 7508544 |
| | RH1V3621HTAN | 36000 [10.6] | 25400 [7.4] | 10600 [3.1] | 15 | 12.5 | 1200 [566.3] | 8086570 |
| | RH1V3621MTAN | 36000 [10.6] | 25100 [7.4] | 10900 [3.2] | 14.5 | 12 | 1200 [566.3] | 7508545 |
| | RH2V3624HTAC | 36000 [10.6] | 25000 [7.3] | 11000 [3.2] | 15 | 12.5 | 1200 [566.3] | 7508546 |
| | RF1P3624SPAN | 36000 [10.6] | 25400 [7.4] | 10600 [3.1] | 13 | 11.5 | 1100 [519.1] | 7886624 |
| | RF1P3624STAN | 36000 [10.6] | 25400 [7.4] | 10600 [3.1] | 13 | 11.5 | 1100 [519.1] | 7886626 |
| | RF1T3624MTAN | 36000 [10.6] | 25400 [7.4] | 10600 [3.1] | 14.5 | 12 | 1025 [483.7] | 7886628 |
| | RBHP-21 | 36000 [10.6] | 24100 [7.1] | 11900 [3.5] | 14 | 11.5 | 1200 [566.3] | 7508556 |
| | RH1P3017STAN | 34200 [10.0] | 23800 [7.0] | 10400 [3.0] | 13 | 11 | 950 [448.4] | 7508907 |
| | RH1T3617STAN | 35200 [10.3] | 24900 [7.3] | 10300 [3.0] | 14 | 11.5 | 1000 [471.9] | 7508908 |
| RA1336AJ1 | RH1T3621HTAN | 36000 [10.6] | 25400 [7.4] | 10600 [3.1] | 15 | 12.5 | 1200 [566.3] | 8086597 |
| | RH1T3621MTAN | 36000 [10.6] | 25000 [7.3] | 11000 [3.2] | 14.5 | 12 | 1175 [554.5] | 7508909 |
| | RH1V3617STAN | 36000 [10.6] | 26800 [7.9] | 9200 [2.7] | 13.5 | 11.5 | 1225 [578.1] | 7508910 |
| | RH1V3621HTAN | 36000 [10.6] | 25400 [7.4] | 10600 [3.1] | 15 | 12.5 | 1200 [566.3] | 8086598 |
| | RH1V3621MTAN | 36000 [10.6] | 25100 [7.4] | 10900 [3.2] | 14.5 | 12 | 1200 [566.3] | 7508911 |
| | RH2V3624HTAC | 36000 [10.6] | 25000 [7.3] | 11000 [3.2] | 15 | 12.5 | 1200 [566.3] | 7508912 |

[] Designates Metric Conversions

Performance Data @ AHRI Standard Conditions – Cooling (con't.)

| Air Handler Ratings | | | | | | | | |
|---------------------|--------------|------------------------------|----------------------------|--------------------------|------|------|---------------------|---------|
| Outdoor Unit | Air Handler | Total Capacity BTU/H [kW] | Net Sensible BTU/H [kW] | Net Latent BTU/H [kW] | SEER | EER | Indoor CFM [L/s] | AHRI# |
| RA1342AC1 | RBHP-24 | 40500 [11.9] | 26900 [7.9] | 13600 [4.0] | 14 | 11.5 | 1400 [660.7] | 7511557 |
| | RH1T4821MTAN | 41500 [12.2] | 29700 [8.7] | 11800 [3.5] | 14 | 11.5 | 1400 [660.7] | 8086653 |
| | RH1T4821STAN | 41000 [12.0] | 30800 [9.0] | 10200 [3.0] | 14 | 11.5 | 1400 [660.7] | 7511783 |
| | RH2T4824MTAN | 42000 [12.3] | 29900 [8.8] | 12100 [3.5] | 14.5 | 12 | 1400 [660.7] | 7511785 |
| | RH1V4821MTAN | 41500 [12.2] | 29700 [8.7] | 11800 [3.5] | 14 | 11.5 | 1425 [672.5] | 8086654 |
| | RH1V4821STAN | 41000 [12.0] | 30800 [9.0] | 10200 [3.0] | 13.5 | 11.5 | 1400 [660.7] | 7511784 |
| | RH2V4824HTAC | 43500 [12.7] | 32600 [9.6] | 10900 [3.2] | 14 | 11.5 | 1600 [755.1] | 7511786 |
| RA1342AJ1 | RBHP-24 | 40500 [11.9] | 26900 [7.9] | 13600 [4.0] | 14 | 11.5 | 1400 [660.7] | 7511791 |
| | RH1T4821MTAN | 41500 [12.2] | 29700 [8.7] | 11800 [3.5] | 14 | 11.5 | 1400 [660.7] | 8086709 |
| | RH1T4821STAN | 41000 [12.0] | 30800 [9.0] | 10200 [3.0] | 14 | 11.5 | 1400 [660.7] | 7512017 |
| | RH2T4824MTAN | 42000 [12.3] | 29900 [8.8] | 12100 [3.5] | 14.5 | 12 | 1400 [660.7] | 7512019 |
| | RH1V4821MTAN | 41500 [12.2] | 29700 [8.7] | 11800 [3.5] | 14 | 11.5 | 1425 [672.5] | 8086710 |
| | RH1V4821STAN | 41000 [12.0] | 30800 [9.0] | 10200 [3.0] | 13.5 | 11.5 | 1400 [660.7] | 7512018 |
| | RH2V4824HTAC | 43500 [12.7] | 32600 [9.6] | 10900 [3.2] | 14 | 11.5 | 1600 [755.1] | 7512020 |
| RA1348AC1 | RBHP-24 | 48000 [14.1] | 31700 [9.3] | 16300 [4.8] | 13.5 | 11.5 | 1600 [755.1] | 7508922 |
| | RH1T4821MTAN | 48000 [14.1] | 34400 [10.1] | 13600 [4.0] | 14 | 11.5 | 1400 [660.7] | 8086745 |
| | RH1T4821STAN | 47500 [13.9] | 33500 [9.8] | 14000 [4.1] | 13.5 | 11.5 | 1400 [660.7] | 7509131 |
| | RH1T4824STAN | 48000 [14.1] | 35000 [10.3] | 13000 [3.8] | 13.5 | 11.5 | 1550 [731.5] | 7509132 |
| | RH2T4824MTAN | 48000 [14.1] | 32000 [9.4] | 16000 [4.7] | 14 | 11.5 | 1400 [660.7] | 7509135 |
| | RH1V4821MTAN | 48000 [14.1] | 34400 [10.1] | 13600 [4.0] | 13.5 | 11.5 | 1625 [766.9] | 8086746 |
| | RH1V4821STAN | 48000 [14.1] | 35100 [10.3] | 12900 [3.8] | 13 | 11.5 | 1575 [743.3] | 7509133 |
| | RH1V4824STAN | 48000 [14.1] | 35500 [10.4] | 12500 [3.7] | 13.5 | 11.5 | 1625 [766.9] | 7509134 |
| RA1348AJ1 | RH2V4824HTAC | 51000 [14.9] | 36400 [10.7] | 14600 [4.3] | 14 | 11.5 | 1600 [755.1] | 7509136 |
| | RBHP-24 | 48000 [14.1] | 31700 [9.3] | 16300 [4.8] | 13.5 | 11.5 | 1600 [755.1] | 7509147 |
| | RH1T4821MTAN | 48000 [14.1] | 34400 [10.1] | 13600 [4.0] | 14 | 11.5 | 1400 [660.7] | 8086781 |
| | RH1T4821STAN | 47500 [13.9] | 33500 [9.8] | 14000 [4.1] | 13.5 | 11.5 | 1400 [660.7] | 7509274 |
| | RH1T4824STAN | 48000 [14.1] | 35000 [10.3] | 13000 [3.8] | 13.5 | 11.5 | 1550 [731.5] | 7509275 |
| | RH2T4824MTAN | 48000 [14.1] | 32000 [9.4] | 16000 [4.7] | 14 | 11.5 | 1400 [660.7] | 7509278 |
| | RH1V4821MTAN | 48000 [14.1] | 34400 [10.1] | 13600 [4.0] | 13.5 | 11.5 | 1625 [766.9] | 8086782 |
| | RH1V4821STAN | 48000 [14.1] | 35100 [10.3] | 12900 [3.8] | 13 | 11.5 | 1575 [743.3] | 7509276 |
| RA1360AC1 | RH1V4824STAN | 48000 [14.1] | 35500 [10.4] | 12500 [3.7] | 13.5 | 11.5 | 1625 [766.9] | 7509277 |
| | RH2V4824HTAC | 51000 [14.9] | 36400 [10.7] | 14600 [4.3] | 14 | 11.5 | 1600 [755.1] | 7509279 |
| | RBHP-25 | 55000 [16.1] | 38300 [11.2] | 16700 [4.9] | 13 | 11 | 1800 [849.5] | 7509290 |
| | RH1T6021STAN | 56000 [16.4] | 39300 [11.5] | 16700 [4.9] | 13 | 11 | 1750 [825.9] | 8086799 |
| | RH1T6024STAN | 57000 [16.7] | 40600 [11.9] | 16400 [4.8] | 13.5 | 11.5 | 1600 [755.1] | 7509404 |
| | RH2T6024STAN | 57000 [16.7] | 40600 [11.9] | 16400 [4.8] | 13.5 | 11.5 | 1600 [755.1] | 7509406 |
| RA1360AJ1 | RH1V6021STAN | 56000 [16.4] | 39000 [11.4] | 17000 [5.0] | 13 | 11 | 1700 [802.3] | 8086800 |
| | RH1V6024STAN | 57000 [16.7] | 40600 [11.9] | 16400 [4.8] | 14 | 11.5 | 1600 [755.1] | 7509405 |
| | RBHP-25 | 55000 [16.1] | 38300 [11.2] | 16700 [4.9] | 13 | 11 | 1800 [849.5] | 7509412 |
| | RH1T6021STAN | 56000 [16.4] | 39300 [11.5] | 16700 [4.9] | 13 | 11 | 1750 [825.9] | 8086817 |
| | RH1T6024STAN | 57000 [16.7] | 40600 [11.9] | 16400 [4.8] | 13.5 | 11.5 | 1600 [755.1] | 7509526 |
| | RH2T6024STAN | 57000 [16.7] | 40600 [11.9] | 16400 [4.8] | 13.5 | 11.5 | 1600 [755.1] | 7509528 |
| RA1360AJ1 | RH1V6021STAN | 56000 [16.4] | 39000 [11.4] | 17000 [5.0] | 13 | 11 | 1700 [802.3] | 8086818 |
| | RH1V6024STAN | 57000 [16.7] | 40600 [11.9] | 16400 [4.8] | 14 | 11.5 | 1600 [755.1] | 7509527 |

[] Designates Metric Conversions

Performance Data @ AHRI Standard Conditions – Cooling (con't.)

| RHWB Hydronic Air Handler Ratings | | | | | | | | | |
|-----------------------------------|----------------------|-------------|------------------------------|----------------------------|--------------------------|------|------|---------------------|---------|
| Outdoor Unit | Hydronic Air Handler | Indoor Coil | Total Capacity BTU/H [kW] | Net Sensible BTU/H [kW] | Net Latent BTU/H [kW] | SEER | EER | Indoor CFM [L/s] | AHRI# |
| RA1324AJ1 | RHWB-04WMX36B | RCF2417HTAM | 24000 [7.0] | 17900 [5.2] | 6100 [1.8] | 14.5 | 12 | 875 [413.0] | 8048996 |
| | | RCF2417MTAM | 24000 [7.0] | 17900 [5.2] | 6100 [1.8] | 14 | 11.5 | 875 [413.0] | 8048997 |
| | | RCF2417STAM | 24000 [7.0] | 17900 [5.2] | 6100 [1.8] | 14 | 11.5 | 875 [413.0] | 8048998 |
| | | RCF2421MTAM | 24000 [7.0] | 17900 [5.2] | 6100 [1.8] | 14 | 11.5 | 875 [413.0] | 8049002 |
| | | RCF2421HTAM | 24000 [7.0] | 17900 [5.2] | 6100 [1.8] | 14 | 11.5 | 875 [413.0] | 8049000 |
| RA1330AJ1 | RHWB-04WMX36B | RCF3617STAM | 28400 [8.3] | 21200 [6.2] | 7200 [2.1] | 14 | 11.5 | 875 [413.0] | 8049008 |
| | | RCF3621MTAM | 30000 [8.8] | 22900 [6.7] | 7100 [2.1] | 14.5 | 12 | 1075 [507.3] | 8049012 |
| | | RCF3621STAM | 28600 [8.4] | 21500 [6.3] | 7100 [2.1] | 14 | 11.5 | 900 [424.8] | 8049016 |
| RA1330AJ1 | RHWB-06WMX48B | RCF3617STAM | 29000 [8.5] | 22100 [6.5] | 6900 [2.0] | 14 | 11.5 | 975 [460.1] | 8049009 |
| | | RCF3621MTAM | 30000 [8.8] | 22900 [6.7] | 7100 [2.1] | 14.5 | 12 | 1000 [471.9] | 8049013 |
| | | RCF3621STAM | 29000 [8.5] | 22200 [6.5] | 6800 [2.0] | 14 | 11.5 | 1000 [471.9] | 8049017 |
| RA1336AC1 | RHWB-04WMX36B | RCF3617STAM | 34800 [10.2] | 24700 [7.2] | 10100 [3.0] | 13.5 | 11.5 | 1025 [483.7] | 8049040 |
| | | RCF3621MTAM | 36000 [10.6] | 25400 [7.4] | 10600 [3.1] | 14 | 11.5 | 1200 [566.3] | 8049044 |
| | | RCF3621STAM | 35000 [10.3] | 25000 [7.3] | 10000 [2.9] | 13.5 | 11.5 | 1050 [495.5] | 8049048 |
| RA1336AC1 | RHWB-06WMX48B | RCF3617STAM | 34800 [10.2] | 24500 [7.2] | 10300 [3.0] | 13.5 | 11.5 | 975 [460.1] | 8049041 |
| | | RCF3621MTAM | 36000 [10.6] | 25400 [7.4] | 10600 [3.1] | 14.5 | 12 | 1000 [471.9] | 8049045 |
| | | RCF3621STAM | 34800 [10.2] | 24500 [7.2] | 10300 [3.0] | 13.5 | 11.5 | 975 [460.1] | 8049049 |
| RA1336AJ1 | RHWB-04WMX36B | RCF3617STAM | 34800 [10.2] | 24700 [7.2] | 10100 [3.0] | 13.5 | 11.5 | 1025 [483.7] | 8049074 |
| | | RCF3621MTAM | 36000 [10.6] | 25400 [7.4] | 10600 [3.1] | 14 | 11.5 | 1200 [566.3] | 8049078 |
| | | RCF3621STAM | 35000 [10.3] | 25000 [7.3] | 10000 [2.9] | 13.5 | 11.5 | 1050 [495.5] | 8049082 |
| RA1336AJ1 | RHWB-06WMX48B | RCF3617STAM | 34800 [10.2] | 24500 [7.2] | 10300 [3.0] | 13.5 | 11.5 | 975 [460.1] | 8049075 |
| | | RCF3621MTAM | 36000 [10.6] | 25400 [7.4] | 10600 [3.1] | 14.5 | 12 | 1000 [471.9] | 8049079 |
| | | RCF3621STAM | 34800 [10.2] | 24500 [7.2] | 10300 [3.0] | 13.5 | 11.5 | 975 [460.1] | 8049083 |
| RA1342AC1 | RHWB-04WMX36B | RCF4821MTAM | 40000 [11.7] | 26600 [7.8] | 13400 [3.9] | 14 | 11.5 | 1100 [519.1] | 8086644 |
| | | RCF4821STAM | 39500 [11.6] | 28200 [8.3] | 11300 [3.3] | 13.5 | 11.5 | 1200 [566.3] | 8049112 |
| RA1342AC1 | RHWB-06WMX48B | RCF4821MTAM | 41000 [12.0] | 29100 [8.5] | 11900 [3.5] | 13.5 | 11.5 | 1375 [648.9] | 8086645 |
| | | RCF4821STAM | 40000 [11.7] | 29000 [8.5] | 11000 [3.2] | 13.5 | 11.5 | 1250 [589.9] | 8049113 |
| RA1342AJ1 | RHWB-04WMX36B | RCF4821MTAM | 40000 [11.7] | 26600 [7.8] | 13400 [3.9] | 14 | 11.5 | 1100 [519.1] | 8086700 |
| | | RCF4821STAM | 39500 [11.6] | 28200 [8.3] | 11300 [3.3] | 13.5 | 11.5 | 1200 [566.3] | 8049144 |
| RA1342AJ1 | RHWB-06WMX48B | RCF4821MTAM | 41000 [12.0] | 29100 [8.5] | 11900 [3.5] | 13.5 | 11.5 | 1375 [648.9] | 8086701 |
| | | RCF4821STAM | 40000 [11.7] | 29000 [8.5] | 11000 [3.2] | 13.5 | 11.5 | 1250 [589.9] | 8049145 |
| RA1348AC1 | RHWB-04WMX36B | RCF4821MTAM | 47500 [13.9] | 31300 [9.2] | 16200 [4.7] | 13 | 11.5 | 1325 [625.3] | 8086739 |
| | | RCF4821STAM | 46500 [13.6] | 32000 [9.4] | 14500 [4.2] | 13 | 11 | 1325 [625.3] | 8049177 |
| RA1348AC1 | RHWB-06WMX48B | RCF4821MTAM | 48000 [14.1] | 32000 [9.4] | 16000 [4.7] | 13 | 11.5 | 1350 [637.1] | 8086740 |
| RA1348AC1 | RHWB-08WRX60B | RCF4824STAM | 47000 [13.8] | 32500 [9.5] | 14500 [4.2] | 13.5 | 11.5 | 1325 [625.3] | 8049188 |
| RA1348AC1 | RHWB-10WRX60B | RCF4824STAM | 48000 [14.1] | 34600 [10.1] | 13400 [3.9] | 13.5 | 11.5 | 1500 [707.9] | 8049189 |
| RA1348AJ1 | RHWB-04WMX36B | RCF4821MTAM | 47500 [13.9] | 31300 [9.2] | 16200 [4.7] | 13 | 11.5 | 1325 [625.3] | 8086775 |
| | | RCF4821STAM | 46500 [13.6] | 32000 [9.4] | 14500 [4.2] | 13 | 11 | 1325 [625.3] | 8049212 |
| RA1348AJ1 | RHWB-06WMX48B | RCF4821MTAM | 48000 [14.1] | 32000 [9.4] | 16000 [4.7] | 13 | 11.5 | 1350 [637.1] | 8086776 |
| RA1348AJ1 | RHWB-08WRX60B | RCF4824STAM | 47000 [13.8] | 32500 [9.5] | 14500 [4.2] | 13.5 | 11.5 | 1325 [625.3] | 8049223 |
| RA1348AJ1 | RHWB-10WRX60B | RCF4824STAM | 48000 [14.1] | 34600 [10.1] | 13400 [3.9] | 13.5 | 11.5 | 1500 [707.9] | 8049224 |
| RA1360AC1 | RHWB-08WRX60B | RCF6024STAM | 56000 [16.4] | 38900 [11.4] | 17100 [5.0] | 13.5 | 11.5 | 1500 [707.9] | 8049254 |
| RA1360AC1 | RHWB-10WRX60B | RCF6024STAM | 57500 [16.9] | 42200 [12.4] | 15300 [4.5] | 13.5 | 11.5 | 1725 [814.1] | 8049255 |
| RA1360AJ1 | RHWB-08WRX60B | RCF6024STAM | 56000 [16.4] | 38900 [11.4] | 17100 [5.0] | 13.5 | 11.5 | 1500 [707.9] | 8049285 |
| RA1360AJ1 | RHWB-10WRX60B | RCF6024STAM | 57500 [16.9] | 42200 [12.4] | 15300 [4.5] | 13.5 | 11.5 | 1725 [814.1] | 8049286 |

[] Designates Metric Conversions

GUIDE SPECIFICATIONS

General

System Description

Outdoor-mounted, air-cooled, split-system air conditioner composite base pan unit suitable for ground or rooftop installation. Unit consists of a hermetic compressor, an air-cooled coil, propeller-type condenser fan, suction and legend line service valve, and a control box. Unit will discharge supply air upward as shown on contract drawings. Unit will be used in a refrigeration circuit to match up to a coil unit.

Quality Assurance

- Unit will be rated in accordance with the latest edition of AHRI Standard 210.
- Unit will be certified for capacity and efficiency, and listed in the latest AHRI directory.
- Unit construction will comply with latest edition of ANSI/ASHRAE and with NEC.
- Unit will be constructed in accordance with UL standards and will carry the UL label of approval. Unit will have c-UL-us approval.
- Unit cabinet will be capable of withstanding ASTM B117 1000-hr salt spray test.
- Air-cooled condenser coils will be leak tested at 150 psig and pressure tested at 550 psig.
- Unit constructed in ISO9001 approved facility.

Delivery, Storage, and Handling

- Unit will be shipped as single package only and is stored and handled per unit manufacturer's recommendations.

Warranty (for inclusion by specifying engineer) – U.S. and Canada only.

Products

Equipment

Factory assembled, single piece, air-cooled air conditioner unit. Contained within the unit enclosure is all factory wiring, piping, controls, compressor, refrigerant charge R-410A, and special features required prior to field start-up.

Unit Cabinet

- Unit cabinet will be constructed of galvanized steel, bonderized, and coated with a powder coat paint.
- All units constructed with louver coil protection and corner post. Louver can be removed by removing one fastener per louver panel.

AIR-COOLED, SPLIT-SYSTEM AIR CONDITIONER

RA13

1-1/2 TO 5 NOMINAL TONS

Fans

- Condenser fan will be direct-drive propeller type, discharging air upward.
- Condenser fan motors will be totally enclosed, 1-phase type with class B insulation and permanently lubricated bearings. Shafts will be corrosion resistant.
- Fan blades will be statically and dynamically balanced.
- Condenser fan openings will be equipped with coated steel wire safety guards.

Compressor

- Compressor will be hermetically sealed.
- Compressor will be mounted on rubber vibration isolators.

Condenser Coil

- Condenser coil will be air cooled.
- Coil will be constructed of aluminum fins mechanically bonded to copper tubes.

Refrigeration Components

- Refrigeration circuit components will include liquid-line shutoff valve with sweat connections, vapor-line shutoff valve with sweat connections, system charge of R-410A refrigerant, and compressor oil.
- Unit will be equipped with filter drier for R-410A refrigerant for field installation.

Operating Characteristics

- The capacity of the unit will meet or exceed _____ Btuh at a suction temperature of _____ °F/°C. The power consumption at full load will not exceed _____ kW.
- Combination of the unit and the evaporator or fan coil unit will have a total net cooling capacity of _____ Btuh or greater at conditions of _____ CFM entering air temperature at the evaporator at _____ °F/°C wet bulb and _____ °F/°C dry bulb, and air entering the unit at _____ °F/°C.
- The system will have a SEER of _____ Btuh/watt or greater at DOE conditions.

Electrical Requirements

- Nominal unit electrical characteristics will be _____ v, single phase, 60 hz. The unit will be capable of satisfactory operation within voltage limits of _____ v to _____ v.
- Nominal unit electrical characteristics will be _____ v, three phase, 60 hz. The unit will be capable of satisfactory operation within voltage limits of _____ v to _____ v.
- Unit electrical power will be single point connection.
- Control circuit will be 24v.

Special Features

- Refer to section of this literature identifying accessories and descriptions for specific features and available enhancements.

GENERAL TERMS OF LIMITED WARRANTY*

Rheem will furnish a replacement for any part of this product which fails in normal use and service within the applicable period stated, in accordance with the terms of the limited warranty.

Conditional Parts
(Registration Required)Ten (10) Years

***For complete details of the Limited and Conditional Warranties, including applicable terms and conditions, contact your local contractor or the Manufacturer for a copy of the product warranty certificate.**



The new degree of comfort.™

In keeping with its policy of continuous progress and product improvement, Rheem reserves the right to make changes without notice.

Rheem Heating, Cooling & Water Heating • P.O. Box 17010
Fort Smith, Arkansas 72917 • www.rheem.com

Rheem Canada Ltd./Ltée • 125 Edgeware Road, Unit 1
Brampton, Ontario • L6Y 0P5



INTEGRATED HOME COMFORT

PRINTED IN U.S.A. 11/16 QG FORM NO. A11-221 REV. 5